

Operation Manual

Level Plus[®] – CHAMBERED

Magnetostrictive Liquid Level Transmitters with Temposonics[®] Technology

- Designed for Magnetic Level Gauge (MLG)
- No scheduled maintenance or recalibration
- Hazardous area certified



Table of contents

1. Contact information	3
2. Terms and definitions	3
3. Introduction	5
3.1 Purpose and use of this manual	5
3.2 Used symbols and warnings	5
4. Safety instructions	5
4.1 Intended use	5
4.3 Installation, commissioning and operation	6
5. Product overview	6
5.1 Components	6
5.2 Foreseeable misuse	6
5.2 Accuracy	8
5.3 Warranty	8
5.4 Storage	8
5.5 Model number identification	9
5.6 Technical data	11
6. Installation and mounting	12
6.1 Training	12
6.2 Tools	12
6.3 Installation steps	12
6.4 Mounting	12
7. Electrical connections	13
7.1 Basic information	13
7.2 Safety recommendations	13
7.3 Industrial topologies	13
7.4 Cable recommendations	14
7.5 Electrical conduit	14
7.6 Grounding	15
7.7 Safety barriers	15
8. Commissioning	16
8.1 Training	16
8.2 Tools	16
8.3 Setup software	16
8.4 Commissioning steps	16
9. Maintenance	17
9.1 Training	17
9.2 Tools	17
9.3 Inspection	17
9.4 Preventative maintenance	17
10. Repair	17
10.1 RMA policy	17
10.2 Training	17
10.3 Tools	17
10.4 Troubleshooting	17
10.5 Setup software	18
11. Spare Parts	18
12. Interface	18
12.1 Modbus	18
12.2 DDA	18
12.3 HART®	18
13. Agency information	19
13.1 Approvals overview	19
13.2 Certificates	20
13.3 FM (NEC)	20
13.4 FMC (CEC)	31
13.5 ATEX, IECEx, and UKCA	46

1. Contact information

United States

General

Tel: +1-919-677-0100
Fax: +1-919-677-2343
E-mail: info.us@temposonics.com
<http://www.temposonics.com>

Mailing and shipping address

Temposonics LLC
3001 Sheldon Drive
Cary, North Carolina, 27513, USA

Customer service

Tel: +1-800-633-7609
Fax: +1-800-498-4442
E-mail: info.us@temposonics.com

Technical support and applications

24 Hour Emergency Technical Support
Tel: +1-800-633-7609
E-mail: levelplus@temposonics.com

Germany

General

Tel: +49-2351-9587-0
Fax: +49-2351-56491
E-mail: info.de@temposonics.com
<http://www.temposonics.com>

Mailing and shipping address

Temposonics GmbH & Co. KG
Auf dem Schüffel 9
58513 Lüdenscheid, Germany

Technical support and applications

Tel: +49-2351-9587-0
E-mail: info.de@temposonics.com
<http://www.temposonics.com>

2. Terms and definitions

6A Heavy Oils

'Generalized Crude Oils', Correction of Volume to 60 °F against API Gravity.

6B Light Oils

'Generalized Products', Correction of Volume to 60 °F against API Gravity.

6C Chemical

'Volume Correction Factors (VCF)' for individual and special applications, volume correction to 60 °F against thermal expansion coefficients.

6C Mod

An adjustable temperature reference for defining VCF.

A

API gravity

The measure of how heavy or light a petroleum liquid is compared to water. Allowable values are 0 to 100 degrees *API* for (6A) and 0 to 85 degrees *API* for (6B).

D

DDA (Direct Digital Access)

The proprietary digital protocol developed by Temposonics for use in intrinsically safe areas.

Density

Mass divided by the volume of an object at a specific temperature. The density value should be entered as lb / cu. ft.

E

Explosion proof

Type of protection based on enclosure in which the parts which can ignite an explosive gas atmosphere are placed within, and which can withstand the pressure developed during an internal explosion of an explosive mixture, and which prevents the transmission of the explosion to the explosive gas atmosphere surrounding the enclosure.

F

Flameproof

Type of protection based on enclosure in which the parts which can ignite an explosive gas atmosphere are placed within and which can withstand the pressure developed during an internal explosion of an explosive mixture, and which prevents the transmission of the explosion to the explosive gas atmosphere surrounding the enclosure.

G

GOVI (Gross Observed Volume of the Interface)

The total volume of the tank occupied by the interface liquid. The *GOVI* is only given when measuring two liquids and is calculated by subtracting the volume of the product from the total volume of liquid in the tank ($GOVT - GOVP$).

GOVP (Gross Observed Volume of the Product)

The total volume of the tank occupied by the product liquid. When measuring only one liquid, it is also the total volume of liquid in the tank (*GOVT*). When measuring two liquids it is the total volume of liquid in the tank minus the volume of the interface liquid ($GOVT - GOVI$).

GOVT (Total Gross Observed Volume)

The total volume of liquid in the tank. When measuring only one liquid it is equal to the volume of the product (*GOVP*). When measuring two liquids it is equal to the volume of the product and interface liquids ($GOVP + GOVI$).

GOVU (Gross Observed Volume Ullage)

The difference in volume between the working capacity of a tank and the total volume in the tank ($Working\ Capacity - GOVT$).

H

HART®

A *Bidirectional communication protocol* that provides data access between intelligent field instruments and host systems.

I

Interface

Noun; The measurement of the level of one liquid when that liquid is below another liquid.

Interface

Adj.; The Software *Graphical User Interface* (GUI) that allows the user to access software protocols (*HART®*, *DDA*, *MODBUS*).

Intrinsic safety

'Intrinsically safe' - Type of protection based on the restriction of electrical energy within apparatus of interconnecting wiring exposed to potentially explosive atmosphere to a level below that which can cause ignition by either sparking or heating effects.

M

Mass

The property of a body that causes it to have weight in a gravitational field, calculated by density at the reference temperature multiplied by the volume correction factor ($Density \times VCF$).

MODBUS

A *serial communications protocol* published by Modicon in 1979 for use with its programmable logic controllers (PLCs). It has become a de facto standard communications protocol in industry, and is now the most commonly available means of connecting industrial electronic devices.

N

NEMA Type 4X

A product *Enclosure* intended for indoor or outdoor use primarily to provide a degree of protection against corrosion, windblown dust and rain, splashing water, and hose-directed water; and to be undamaged by the formation of ice on the enclosure. They are not intended to provide protection against conditions such as internal condensation or internal icing.

NPT

U.S. standard defining tapered pipe threads used to join pipes and fittings.

NSVP (Net Standard Volume of the Product)

The temperature corrected volume for the product liquid in the tank, requires the transmitter to be ordered with temperature measurement capabilities. The *NSVP* is calculated by multiplying the volume of the product liquid by a volume correction factor based on temperature ($GOVP \times VCF$).

R

Reference Temperature

The *temperature* at which the density measurement is given, the allowable values are 32 °F to 150 °F (0 °C to 66 °C).

S

Specific Gravity

The *density ratio* of a liquid to the density of water at the same conditions.

Sphere Radius

The *internal radius* of the sphere that contains the liquid, the value is used to calculate the volume along with the *Sphere Offset*.

Sphere Offset

An *offset value* that accounts for additional volume in a sphere from non-uniform sphere geometry, the value is used to calculate the volume along with the *Sphere Radius*.

Strap Table

A *table of measurement* correlating the height of a vessel to the volume that is contained at that height. The transmitter can contain up to 200 points.

T

TEC

'Thermal Expansion Coefficient' - a value correlating the change in temperature for an object with the change in its volume. Allowable values are 270.0 to 930.0. TEC units are in 10 E-6/Deg F.

Temperature Correction Method

One of five *product correction methods* used to correct the product volume in the tank due to changes in temperature from 60 °F including (6A, 6B, 6C, 6C Mod, and Custom Table).

V

Volume Calculation Mode

One of two methods use to calculate volume measurements from level measurements, including *Sphere* and *Strap Table*.

VCF (Volume Correction Factor)

A table of measurements correlating temperature points with correction factors for the liquids expansion/contraction. The transmitter can contain up to 50 points.

W

Working Capacity

The *maximum volume of liquid* that the user desires for their vessel to hold, typically 80% of the vessels maximum volume before overflow.

3. Introduction

3.1 Purpose and use of this manual

Important:

Before starting the operation of the equipment read this documentation thoroughly and follow the safety information.

The content of this technical documentation and of its various annexes is intended to provide information on mounting, installation and commissioning by qualified service personnel according to IEC 60079-14 and local regulations or Temposonics trained service technicians.

3.2 Used symbols and warnings

Warnings are intended for your personal safety and for avoidance of damage to the described product or connected devices. In this documentation, safety information and warnings to avoid dangers that might affect the life and health of personnel or cause material damage are highlighted by the preceding pictogram, which is defined below.

Symbol	Meaning
	This symbol is used to point to situations that may lead to material damage and/or personal injury.

4. Safety instructions

4.1 Intended use

The liquid level transmitter is intended to be used to measure the level of liquid(s) contained by a structure as well as the temperature of the liquid. The product may only be used for the applications defined under item 1 to item 4 and only in conjunction with third-party devices and components recommended or approved by Temposonics. As a prerequisite of proper and safe operation, the product requires correct transport, storage, mounting and commissioning and must be operated with utmost care.

1. Application does not exceed product's performance specification in chapter 5.6.
2. Product may only be installed in hazardous areas as specified by approval certifications in chapter 13 following special conditions of use outlined in chapter 13 or in safe areas.
3. The liquid(s) being measured are compatible with the selected wetted parts of the product.
4. Temposonics floats should be used for proper functionality and safety approval.

4.2 Foreseeable misuse

Foreseeable misuse	Consequence
Wrong sensor connection	Possible damage to electronics See chapter 7 for Electrical Connections
Improper Installation	Physical damage to packaging See chapter 6 for Installation
Installation in unapproved Hazardous Area	Potential Spark See chapter 13 for Agency Information
Process Temperature out of range	Signal Degradation, Possible Damage to Sensor See chapter 5.6 for Specifications
Power Supply out of range	No Communication, Possible Damage to Sensor See chapter 5.6 for Specifications
Process Pressure out of range	Possible Damage to Sensor, See chapter 5.6 for Specifications
Improper Chemical Compatibility	Possible Damage to Sensor, Customer Must Select Wetted Material that is compatible with liquid(s) in tank
Modifying Sensor	Warranty Void, Hazardous Approval Void Customer should contact factory for custom unit
Improper Grounding	Possible Damage to Sensor, Full Protection Compromised, See chapter 7.6 for Grounding

Table 1: Foreseeable misuse

4.3 Installation, commissioning and operation

1. Wear proper personal protection equipment such as hard hat, safety shoes, flame resistant clothing, safety glasses, gloves, and hearing protection.
2. Follow the specifications given in the technical documentation.
3. Two (2) individuals are recommended to conduct proper installation, commissioning, and repair of the level transmitter.
4. Ensure the equipment used in a hazardous environment is selected and installed in compliance with regulations governing the geographical installation and facility. Only install equipment that complies with the types of protection relevant to the applicable classes, division, zones, category, gas group, and temperature code.
5. Protect the sensor against mechanical damage during installation and operation.
6. Do not use damaged products and secure them against unintentional use. Mark damaged products as being defective.
7. Connect the sensor very carefully and pay attention to the polarity of connections. Temposonics recommends to not make connections while power is live.
8. Before turning on power, ensure that nobody's safety is jeopardized by starting level transmitter and/or process.
9. Regularly follow preventative maintenance to prevent safety risks

10. Make sure that no wire strands are loose or sticking out of the terminal block connection which could short and cause a problem.

11. Make sure that no wire strands, including shield, are in contact with the electronic module enclosure.

5. Product overview

The Level Plus® CHAMBERED Liquid-Level transmitter is a continuous multi-functional magnetostrictive transmitter that provides product level and interface level to the user via Modbus, DDA, Analog (4 to 20 mA), or HART®. Magnetostrictive technology is one of the most accurate and repeatable level technologies available to date.

Temposonics is the inventor and purveyor of magnetostrictive technology and has been serving the level industry for over 35 years.

Industries

- Petroleum
- Liquid Petroleum Gas
- Pharmaceutical
- Food & Beverage
- Chemical
- Mining

5.1 Components

The Level Plus® CHAMBERED liquid level transmitter consists of three main components; a housing, outer pipe, and electronics. Varying the components of the transmitter allows the transmitter to be customized to almost any application.

Housings

Level Plus® CHAMBERED transmitters are available in two housing configurations: single and dual cavity housings as shown below. The conduit openings on the single cavity housings (options D, L) and standard electronic mount (7,8) are 3/4" NPT opening for FM and FMC approvals and M20 opening for ATEX and IECEx approvals. The conduit openings on the single cavity housing (options D,L) and 90 degree electronic mount (3,4,5,6) are 3/4" NPT for all approvals and a M20 adapter is supplied for ATEX and IECEx approvals. The conduit opening on the dual cavity housing option (E) always requires the 90 degree electronic mount (3,4,5,6) and is supplied with 3/4" NPT opening for FM and FMC approvals and M20 opening for ATEX and IECEx approvals.

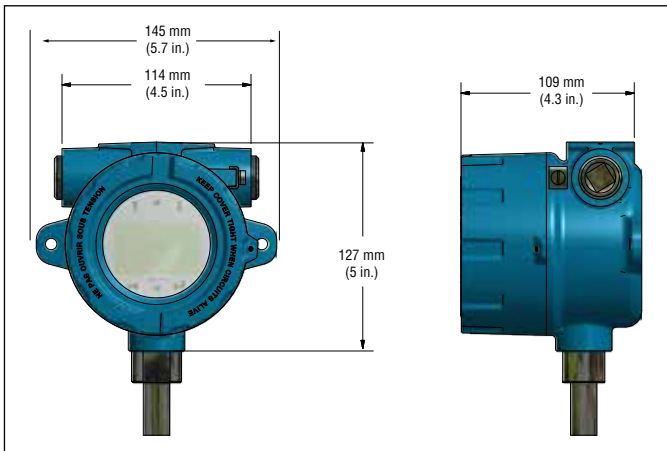

Fig. 1: Single cavity housing

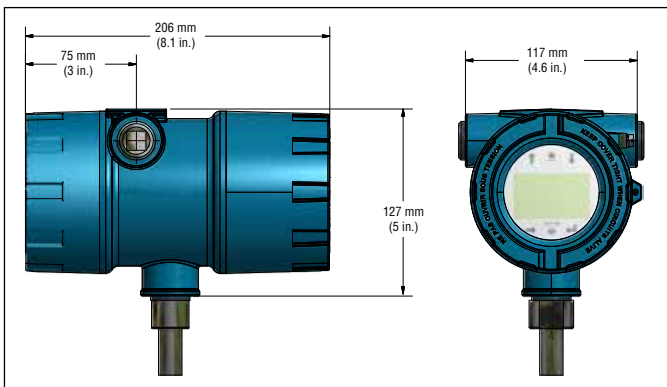

Fig. 2: Dual cavity housing

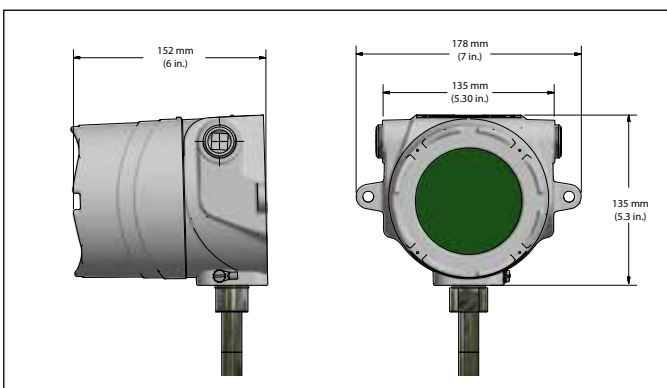

Fig. 3: Stainless steel single cavity housing

Outer pipe configurations

The outer pipe is constructed of a variety of configurations. The CHAMBERED is available in a rigid pipe. For other pipe options please consult other Temposonics options such as Tank Slayer®, RefineMe®, SoClean®.

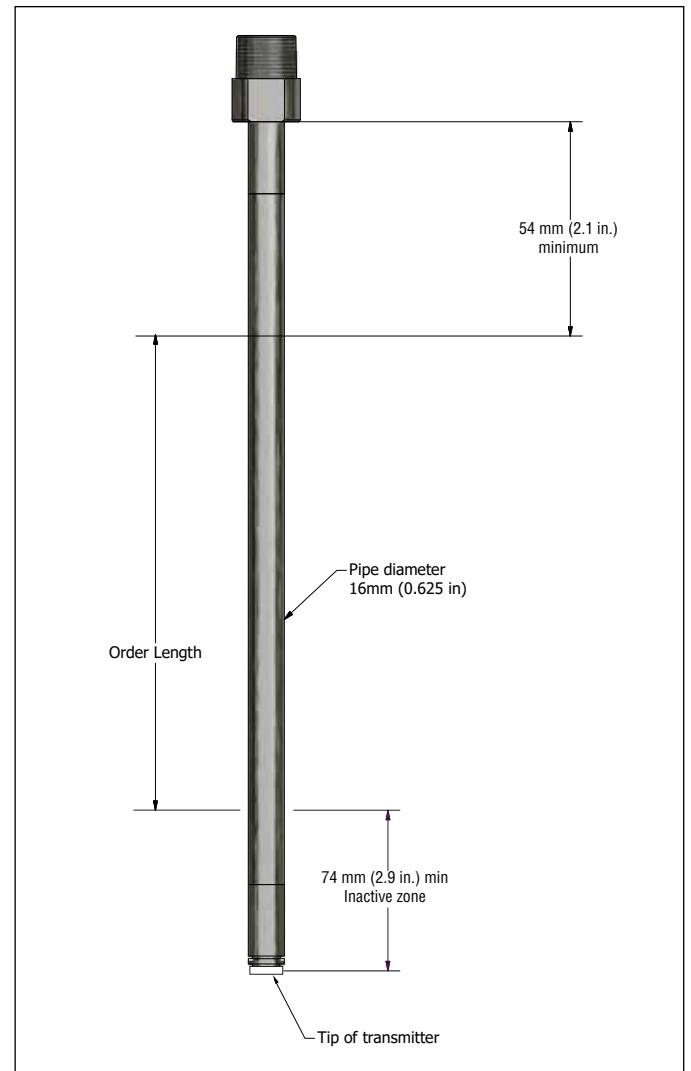

Fig. 4: Stainless steel single cavity housing

Internal electronics

All transmitters come with two electronic components of a sensing element and a board set. Rigid sensing elements are standard on CHAMBERED. The board set consists of up to three electronic boards and a display.

A temperature sensing function is optional with the CHAMBERED transmitter. The temperature sensing device is a Digital Thermometer mounted inside the transmitter's outer pipe assembly. The CHAMBERED can be ordered with 1, 5, 12, or 16 temperature points.

Display

All LP-Series liquid level transmitters are shipped with a stylus (Part # 404108) to be used for manipulating the display. For single and dual cavity housings, the stylus is designed to allow for programming of the unit without removing the housing. When using the stylus make sure to align the stylus with the shape outline around the buttons in the same orientation. Failure to correctly align the stylus can cause the display to not function properly. Password for entering the menu is 27513. For additional details consult the protocol specific Modbus Interface Manual (Part #551700), DDA Interface Manual (Part #551701), and HART® Interface Manual (Part #551702).

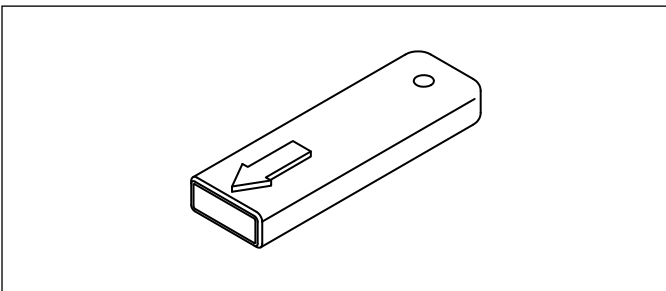

Fig. 5: Stylus (Part # 404108)

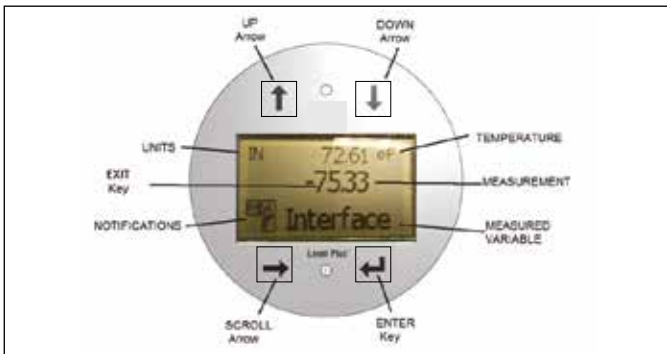

Fig. 6: Display

Accessories

Temposonics also offers a series of displays, housings, converters, and other accessories, please refer to the 'Accessories Catalog', (Part #551103).

5.2 Accuracy

For magnetostrictive transmitters inherent accuracy is measured in terms of non-linearity. Non-linearity is a measurement of any imperfections in the waveguide that are reflected in the linearity of the transmitter's output. Temposonics tolerances reflect a maximum non-linearity of ± 1 mm. Temposonics is able to achieve such strict tolerances by manufacturing all of its own waveguide from a proprietary alloy and testing 100% of all transmitters before shipping.

5.3 Warranty

Important:

Contact Technical Support or Customer Service for assistance if you suspect that the transmitter is not working correctly. Technical support can assist you with troubleshooting, part replacement, and Returned Material Authorization (RMA) information if required.

All Level Plus® transmitters come with a two year limited warranty from the factory shipment date. An additional extended warranty can be purchased. A Return Materials Authorization (RMA) number is required and must accompany any transmitter returns. Any unit that was used in a process must be properly cleaned in accordance with OSHA standards, before it is returned to the factory. A Material Safety Data Sheet (MSDS) must also accompany the transmitter that was used in any process.

5.4 Storage

If storage is required prior to installation, store indoors in a dry environment at ambient temperature range not to exceed $-40...+71^{\circ}\text{C}$ ($-40...+160^{\circ}\text{F}$).

5.5 Model number identification

1	2	3	4	5	6	7	8	9	10	11	12	13	14	15	16	17	18	19	20	21	22
L	P	C																			
a			b	c	d	e	f	g	h	i	j	k	l	m	n	o					p

a	Sensor model		
L	P	C	CHAMBERED Level Transmitter

b	Output
M	Modbus
D	DDA
3	1 Loop with HART®
6	1 Loop with HART® and SIL 2

c	Housing type
D	Single cavity with display
E	Dual cavity with display
L	SS single cavity w/display

d	Electronics mounting
3	90° bend housing top left
4	90° bend housing top right
5	90° bend housing bottom left
6	90° bend housing bottom right
7	Top mount
8	Bottom mount

e	Sensor pipe
B	5/8" OD pipe
R	1/2" OD pipe
Y	10 mm OD pipe

f	Materials of construction (Wetted parts)*
1	316L stainless steel

g	Process connection type
X	None

h	Process connection size
X	None

i	Number of DT's (Digital Thermometers)
0	None

j	DT's placement
X	None

k	Notified body
B	INMETRO
C	CEC (FMC)
E	ATEX
F	NEC (FM)
I	IEC
K	KC
N	NEPSI
T	CML/TIIS
P	CCOE
U	UKCA
X	None

l	Protection method
F	Explosion proof / Flameproof (only for housing type D, E, or L)
I	Intrinsically safe
X	No approval

m	Gas group
A	Group A (not available with "C = CEC (FMC)" notified body and "F = Flameproof/Explosion proof" protection method)
B	Group B
C	Group C
D	Group D
3	IIC (Intrinsically Safe only)
4	IIB + H2 (Explosion Proof / Flameproof only)
X	None

Continued on next page...

*/ Contact factory for other materials

Level Plus® CHAMBERED

Operation Manual

1	2	3	4	5	6	7	8	9	10	11	12	13	14	15	16	17	18	19	20	21	22
L	P	T																			
a			b	c	d	e	f	g	h	i	j	k	l	m	n	o					p

n	Unit of measure
M	Millimeters (Metric)
U	Inches (US customary)

o	Length (no decimal spaces) *				
X	X	X	X	X	Rigid Pipe: 12 to 144 in (code as 01200 to 14400)
X	X	X	X	X	Rigid Pipe: 305 to 3658 mm (code as 00305 to 03658)

p	Special
S	Standard product

NOTICE

Accessories such as floats, cables, and remote displays have to be ordered separately. All accessories are shown in the Accessories Catalog (Part #551103).

* / Contact factory for longer lengths

5.6 Technical data

Level Output	
Measured Variable	Product level
Output Signal /Protocol	Modbus RTU, DDA, Analog (4...20 mA), HART®
Order Length	305 mm (12 in.) to 3658 mm (144 in.) (order length equals the measurement range / contact factory for longer lengths)
Inherent Accuracy	±1 mm (0.039 in.)
Repeatability	0.001% F.S. or 0.381 mm (0.015 in.) whichever is greater * (any direction)
Temperature Output	
Measured Variable	Average and multipoint temperatures (Modbus, DDA) Single point temperature (Analog, HART®)
Temperature Accuracy (Modbus, DDA)	±0.2 °C (0.4 °F) range -40...-20 °C (-40...-4 °F), ±0.1 °C (0.2 °F) range -20...+70 °C (-4...+158 °F), ±0.15 °C (0.3 °F) range +70...+100 °C (+158...+212 °F), ±0.5 °C (0.9 °F) range +100...+105 °C (+ 212 ...221 °F)
Temperature Accuracy (Analog, HART®)	±0.28 °C (0.5 °F) range -40...+105 °C (-40...+221 °F)
Electronics	
Input Voltage	10.5...28 VDC
Fail Safe	High, Full scale (Modbus, DDA) Low, 3.5 mA default or High, 22.8 mA (Analog, HART®)
Reverse Polarity Protection	Series diode
EMC	EN 61326-1, EN 61326-2-3, EN 61326-3-2, EN 61000-6-2, EN 61000-6-3, EN 61000-4-2, EN 61000-4-3, EN 61000-4-4, EN 61000-4-5, EN 61000-4-6, EN 61000-4-8, EN 61000-4-11
Environmental	
Enclosure Rating	NEMA Type 4X, IP65
Humidity	0...100% relative humidity, non-condensing
Operating Temperatures	Electronics: -40...+71 °C (-40...+160 °F) Sensing element: -40...+125 °C (-40...+257 °F) (contact factory for specific temperature ranges)
Materials	316L stainless steel, Epoxy coated aluminum
Field Installation	
Housing Dimensions	Single cavity: 145 mm (5.7 in.) W × by 127 mm (5 in.) D × 109 mm (4.3 in.) H Dual cavity: 117 mm (4.6 in.) W × by 127 mm (5 in.) D × 206 mm (8.1 in.) H Stainless steel single cavity: 178 mm (7.1 in.) W × by 135 mm (5.3 in.) D × 153 mm (6 in.) H
Mounting	
Flexible hose	1 in. Adjustable MNPT or BSPP fitting, Flange mount
Wiring	
Connections	4 wire shielded cable or twisted pair
Electrical connections	
Single and dual cavity	¾ in. FNPT conduit opening, M20 for ATEX/IECEX/UKCA version
NEMA Type 4X	½ in. FNPT conduit opening
Display	
Measured variables	Product level, interface level and temperature

*/ Only with Temposonics recommended floats

6. Installation and mounting

6.1 Training

Warning:

When the pipe/hose of the LP-Series level transmitter is installed or removed from the tank the release of flammable vapors will occur. Take all necessary precaution when installing or removing the level transmitter due to the release of flammable vapors.

Installation should only be conducted by qualified service personnel according to IEC 60079-14 and local regulations or Temposonics trained service technicians. Temposonics offers web based and in person training for installation, commissioning, maintenance, and repair. Temposonics also offers factory direct services for these same functions. Contact Temposonics to discuss training or factory direct services before starting.

6.2 Tools

- Channel Lock pliers
- Common head screwdriver, slotted screwdriver
- Additional tools may be needed dependent on MLG manufacturer

6.3 Installation steps

Caution

It is recommended that assembly and mounting of this transmitter should not be done alone. To ensure proper and safe assembly of the CHAMBERED transmitter, a minimum of two (2) individuals are recommended. Gloves are also recommended. PPE is required for work areas such as safety shoes, safety glasses, hard hat, and fire resistant clothing.

1. Consult Section 4.3 before starting.
2. Perform steps 1-9 in section 8.4.1 for Modbus or DDA.
Perform steps 1-8 in section 8.4.2 for Analog.
3. CHAMBERED should come installed on MLG chamber. Typical installation uses a mounting bracket or hose clamps to secure CHAMBERED to MLG. Contact MLG manufacture for installation details.

6.4 Mounting

The method of mounting the transmitter is dependent on the MLG in which it is being used. Typical mounting of CHAMBERED is direct to

Caution

The ambient temperature rating, $T_a = -40\text{ }^\circ\text{C} (-40\text{ }^\circ\text{F})$ to $71\text{ }^\circ\text{C} (160\text{ }^\circ\text{F})$, must not be exceeded due to the mounting of the level transmitter to the MLG and exposure to the process temperature.

the MLG.

Direct mounting

In most applications, the CHAMBERED transmitter can be mounted directly to the MLG via hose clamps. Consult the MLG manufacturer for details.

Caution

When mounting the level transmitter to a MLG, a minimum spacing of 5 inches shall be maintained between the enclosure head and the pressure barrier. The enclosure and pressure barrier are identified in the following depiction.

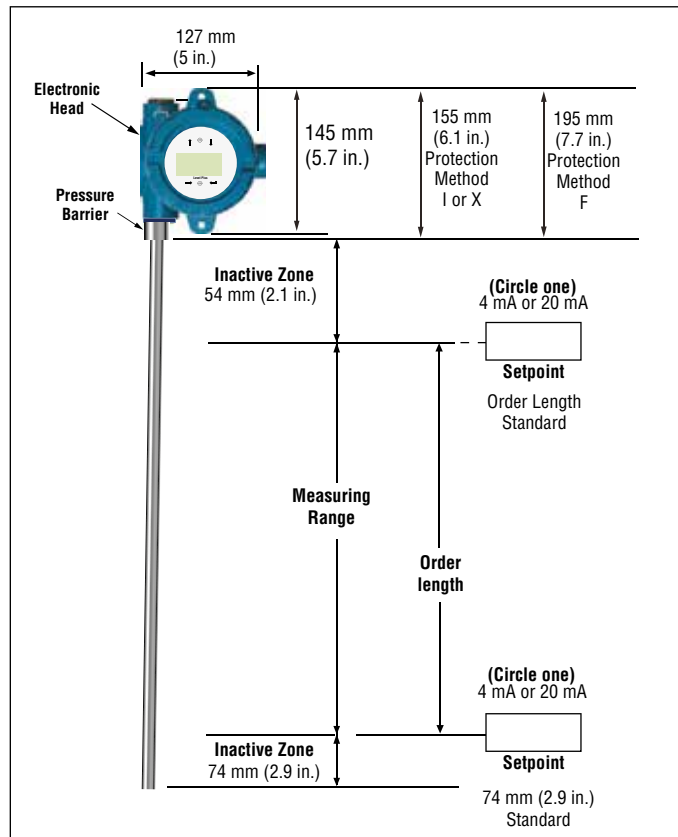

Fig. 7: CHAMBERED mounting, bottom flange

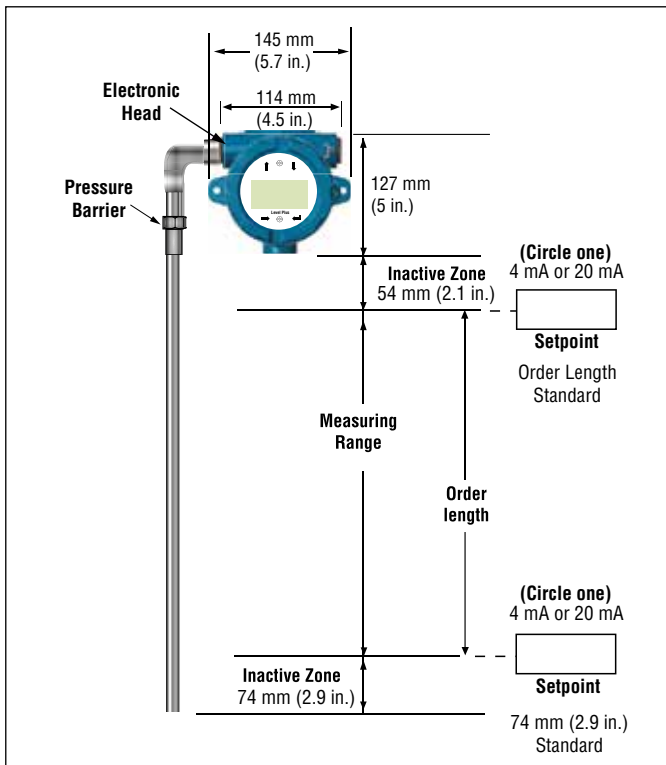

Fig. 8: CHAMBERED mounting, top and bottom flange

7. Electrical connections

7.1 Basic information

A typical intrinsically safe connection for the Level Plus® CHAMBERED transmitter includes protective safety barriers, a power supply and a reading or monitoring device. Refer to Agency information in chapter 13.

A typical Explosion proof/flameproof connection for the Level Plus® CHAMBERED transmitter includes a power supply and a reading or monitoring device. All cabling is in approved conduit with sealoffs as specified by local electrical code. Refer to agency information in chapter 13.

7.2 Safety recommendations

Be sure to:

1. Always follow applicable local and national electrical codes and observe polarity when making electrical connections.
2. Never make electrical connections to the CHAMBERED transmitter with power turned on.
3. Make sure that no wire strands are loose or sticking out of the terminal block connection which could short and cause a problem.

4. Make sure that no wire strands, including shield, are in contact with the electronic module enclosure.
5. The electronics module enclosure is grounded through internal circuitry and is electrically isolated from the explosion proof housing.

7.3 Industrial topologies

There are four topologies described and illustrated below. However, the daisy chain topology is not recommended by Temposonics.

Point-to-point

The point-to-point topology consists of having only one device on the loop as shown in Fig. 9. This topology is not usually used with a bus network since it does not take advantage of placing multiple devices on a loop.

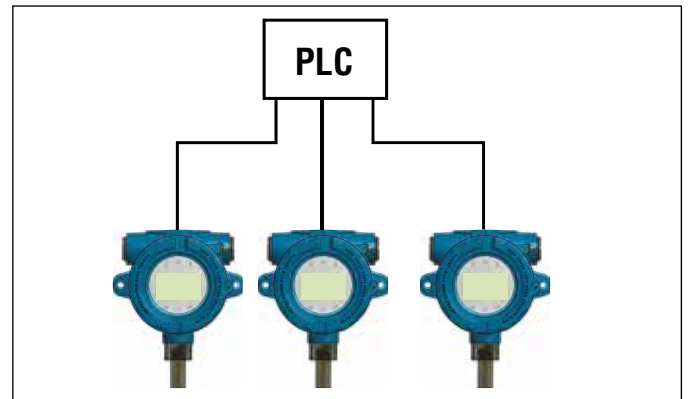

Fig. 9: Point-to-point topology

Bus with spurs

The bus with spurs topology has a main trunk cable that has each device connected via its own spur at a junction box as shown in Fig. 10. The bus with spurs and tree topologies can also be used together to form a hybrid topology.

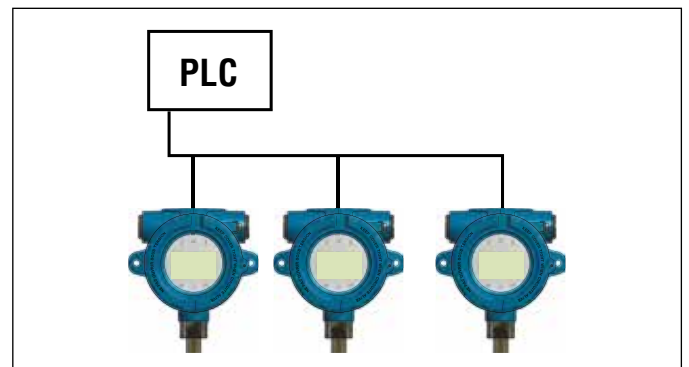

Fig. 10: Bus with spurs topology

Tree alignment

The tree topology is very similar to the bus with spurs topology with the main difference of having a common junction box for all of the transmitters as shown in Fig. 11. Bus with spurs and tree topologies can also be used together to form a hybrid topology.

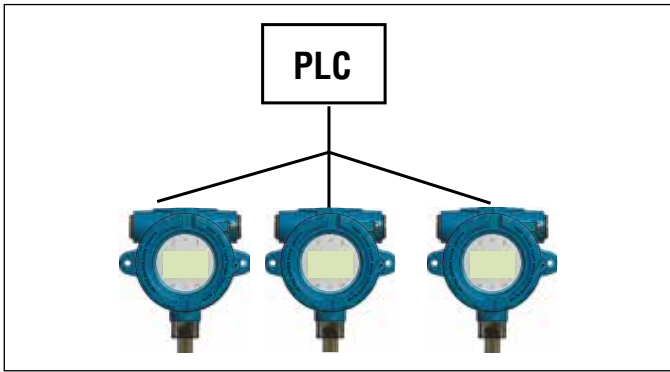

Fig. 11: Tree topology

Daisy chain

The daisy-chain topology utilizes a single cable that is connected to all of the transmitters with the cable being interconnected at each field device. When using this topology make sure that the wiring practice allows for one transmitter to be disconnected without disconnecting the entire loop as shown in Fig. 12. Temposonics does not suggest using the daisy-chain topology.

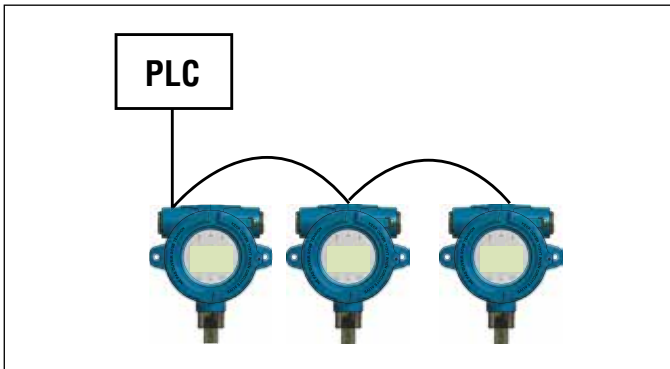

Fig. 12: Daisy-chain topology

7.4 Cable recommendations

Refer to 'Table 2' below for general requirements of cable types for the Level Plus® CHAMBERED transmitter.

Cable specifications

Parameter	Specification
Minimum cable size	Ø 0.51...1.6 mm (24...14 AWG)
Cable type	Single pair shielded or multiple pair with overall shield; minimum 0.25 mm (0.010 in.) insulation thickness
Capacitance	Less than 98 pF/m (30 pF/ft)

Table 2: Cable specification and parameters

7.5 Electrical conduit

NOTICE

1. Tighten housing cover (both front and back covers if dual cavity) to full stop against the O-ring.
2. Use side conduit entry only.
3. In high humidity areas, use a breather drain type conduit sealing fitting to minimize moisture intrusion.
4. For Division Installations, an approved conduit seal is required within 457 mm (18 in.) of the enclosure.
5. For Zone Installations, an approved conduit seal is required within 50mm (2 in.) of the enclosure.

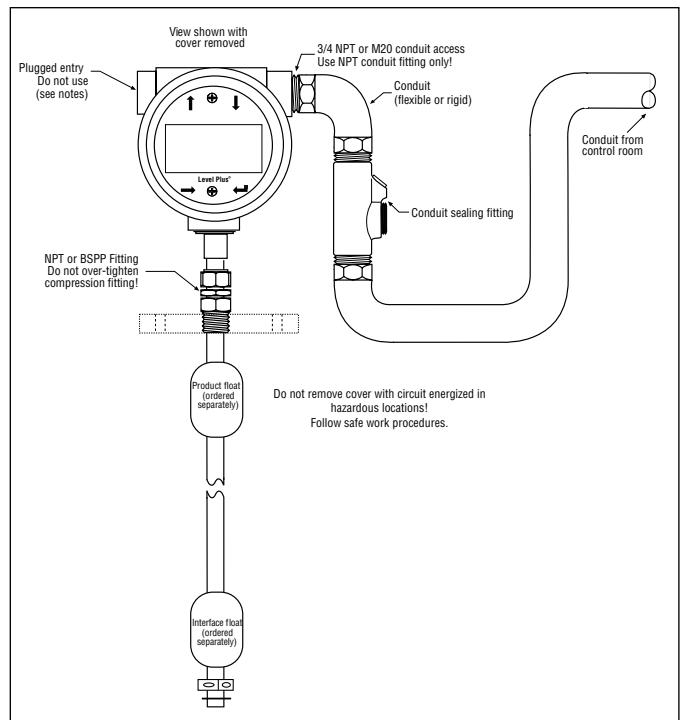

Fig. 13: Electrical conduit installation

7.6 Grounding

7.6.1 Safety grounding

Warning:

Grounding the transmitter through a threaded conduit connection does not meet the requirements as a grounding of the sensor for safety.

There are two methods to provide an earth ground connection to the earth ground of the electronics. Either method must result in a resistance of less than 1 Ω. Refer to 'Table 3' for safety barrier references.

- Run an earth ground through the conduit and connect directly to the earth ground lug inside the housing.
- Run an earth ground directly to the ground lug on the outside of the housing.

7.6.2 Shield grounding

Warning:

The shield ground does not meet the requirements as grounding of the sensor for safety.

Immunity performance of the sensor from external sources of surge, burst, RF, radiated emissions and other noise is dependent on a proper ground for the shield of the communications cable. The communications cable shield should be of a braided type and connected to the internal ground lug of the sensor housing.

Runs in a continuous metallic conduit

When installed inside a dedicated continuous metallic conduit, the conduit provides a level of shielding protection from external interference and a level of ground to the sensor housing. In this case a foil type shielded cable with a drain wire connected to the internal ground lug may be sufficient. Sharing of the metallic conduit with other cables will result in loss of effective shielding performance of the communication cable and possible degradation in performance of the sensor. In this case a braided type shielded cable connected to the sensor internal ground lug would be recommended. In all cases paralleling the communications cable with any noise generating cable inside of a conduit or with noise generating cables in close proximity to the conduit may degrade the performance of the sensor.

Runs without a conduit

In some rare applications, or where safety may not be required, a metallic conduit may not exist. The communications cable shield should be of a braided type and connected to the internal ground lug of the sensor housing. Alternatively a safety approved EMC Cable Gland can be used for grounding the shield. Contact Temposonics for information before using one of these cable glands.

NEC

Undesirable currents (ground loops) is a violation of the NEC and is a safety hazard.

7.7 Safety barriers

Refer to Table 3 for entity parameters and Table 4 for example safety barriers.

Entity parameters	
Digital supply (1 per LT)	U _i = 28 VDC
	I _i = 100 mA
	C _i = 0.0 μF
	L _i = 0 mH
	P _i = 700 mW
Digital communication (2 per LT)	U _i = 8.6 VDC
	I _i = 10 mA
	C _i = 0.0 μF
	L _i = 0.0 mH
	P _i = 21.5 mW
Analog (1 per loop)	U _i = 28 VDC
	I _i = 120 mA
	C _i = 0 μF
	L _i = 5 μH
	P _i = 840 mW

Table 3: Safety barrier entity parameter references

Supplier	STAHL	STAHL	STAHL
Type	9001/01-280-100-101	9001/51-280-110-141	9001/01-086-010-101
Maximum voltage	28 VDC	28 VDC	8.6 VDC
Maximum current (each channel)	100 mA	110 mA	10 mA
Maximum power (each channel)	700 mW	770 mW	21.5 mW
Number of channels	1	1	1
Interface	Modbus/DDA	HART®	Modbus/DDA

Table 4: Safety barrier entity parameter references

8. Commissioning

8.1 Training

Commissioning should only be conducted by qualified service personnel according to IEC 60079-14 and local regulations or Temposonics trained service technicians. Temposonics offers web based and in person training for installation, commissioning, maintenance, and repair. Temposonics also offers factory direct services for these same functions. Contact Temposonics to discuss training or factory direct services before starting.

8.2 Tools

- Channel Lock pliers
- RS485 to USB Converter (Part # 380114)[Modbus and DDA]
- Windows Based PC
- Linear Regulated Power Supply
- LP Dashboard
- HART® to USB Converter (Part # 380068)

8.3 Setup software

Temposonics offers Setup Software that is shipped with the level transmitter and is also available for download from www.temposonics.com. The Setup Software is to be used for installation, commissioning, and troubleshooting. For further details on how to use the setup software consult the Modbus Interface Manual (Part# 551700), the DDA Interface Manual (Part# 551701), and HART® Interface Manual (Part#: 551702).

NOTICE

For Additional details consult the protocol specific Modbus Interface Manual (Part #551700), DDA Interface Manual (Part #551701), and HART® Interface Manual (Part #551702).

8.4 Commissioning steps

8.4.1 Modbus or DDA

1. Consult Section 4.3 before starting
2. Remove level transmitter from shipping container.
3. Mount on MLG and test unit with float from MLG
4. Connect power, RS485 to USB converter, and PC.
5. Open LP Dashboard.
6. Establish Communication.
7. For DDA Interface – Set Address. Default 192.
8. For Modbus Interface – Set Address, Default address 247.
9. Disconnect Power and Communication.
10. Complete Installation in Section 6.4.
11. Have qualified technician perform hand measurement. Enter hand measurement into LP Dashboard and calibrate.
12. Store all settings as backup file according to site name and tank number.

8.4.2 HART®

4. Consult section 4.3 before starting.
5. Remove level transmitter from shipping container.
6. Mount on MLG and test with float from MLG.
7. Connect power, HART® to USB converter, and PC
8. Open LP Dashboard.
9. Establish Communication.
10. Set/Update 4 and 20 mA setpoints
11. Disconnect Power and Communication.
12. Complete Installation in Section 6.4.
13. Have qualified technician perform hand measurement. Enter hand measurement into LP Dashboard and calibrate.
14. Store all settings as backup file according to site name and tank number

9. Maintenance

9.1 Training

Maintenance should only be conducted by qualified service personnel according to IEC 60079-14 and local regulations or Temposonics trained service technicians. Temposonics offers web based and in person training for installation, commissioning, maintenance, and repair. Temposonics also offers factory direct services for these same functions. Contact Temposonics to discuss training or factory direct services before starting.

9.2 Tools

- Channel Lock pliers
- Common head screwdriver, slotted screwdriver

9.3 Inspection

Below are some standard items that should be inspected on a regular basis to make sure that the level transmitter and surrounding environment are in operating condition.

- Hazardous Area Label is present and legible
- Hazardous Area approval is correct for installation
- There are no visible unauthorized modifications
- Electrical connections are tight
- Condition of enclosure O-ring is satisfactory
- No water ingress (white powder)
- No obvious damage to cable
- Sealing of conduit or cable gland is satisfactory
- Earth ground is satisfactory
- Single or Dual Cavity Enclosure threads are not damaged
- Housing and o-ring are not damaged or cracked
- No corrosion on visible parts
- Printed circuit boards are clean and undamaged

9.4 Preventative maintenance

Level Plus® level transmitters do not typically require preventative maintenance but may require preventative maintenance dependent on the application. For general purpose applications where there is no potential for buildup on the flexible hose and/or float there is no need for preventative maintenance but routine inspection is still suggested. For severe service applications where there is potential for buildup on the flexible hose and/or float then preventative maintenance is required.

10. Repair

10.1 RMA policy

Important:

Contact Technical Support or Customer Service for assistance if you suspect that the transmitter is not working correctly. Technical support can assist you with troubleshooting, part replacement, and Returned Material Authorization (RMA) information if required.

All Level Plus® transmitters come with a two year limited warranty from the factory shipment date. A Return Materials Authorization (RMA) number is required and must accompany any transmitter returns. Any unit that was used in a process must be properly cleaned in accordance with OSHA standards, before it is returned to the factory. A Material Safety Data Sheet (MSDS) must also accompany the transmitter that was used in any process.

10.2 Training

Repair should only be conducted by qualified service personnel according to IEC 60079-14 and local regulations or Temposonics trained service technicians. Temposonics offers web based and in person training for installation, commissioning, maintenance, and repair. Temposonics also offers factory direct services for these same functions. Contact Temposonics to discuss training or factory direct services before starting.

10.3 Tools

- Channel Lock pliers
- Phillips head screwdriver, plus screwdriver
- Common head screwdriver, slotted screwdriver
- RS485 to USB Converter (Part # 380114)
[Modbus and DDA]
- Windows Based PC
- Linear Regulated Power Supply
- HART® to USB Converter (Part # 380068)

10.4 Troubleshooting

Symptom	Possible cause	Action
No communication with transmitter	No power	Check voltage at transmitter
	Wiring incorrect	Reference installation drawing chapter 13
	Wrong address	DDA factory default is '192' Modbus factory default is '247'
	Wrong software	Confirm correct software
	Wrong protocol	Confirm software and transmitter are same protocol

Symptom	Possible cause	Action
Missing magnet error or Alarm output	Float not recognized	Confirm that the float is attached
	Float is in the dead zone	Raise float to see if the error stops
	Wrong number of floats selected	Confirm that the number of floats on the transmitter and the number of floats the transmitter is attempting to verify are the same.
Trigger level error	Gain needs to be adjusted	Consult Factory
	SE is damaged	Consult Factory
	Min. trigger level too high	Consult Factory
Volume calculation error	No strap table entered	Enter strap table
	Level outside range of strap table	Enter additional points in strap table
	Strap table incorrect	Check value entries
VCF error	No VCF table entered	Enter VCF table
	VCF table incorrect	Check VCF value entries

Table 5: Troubleshooting reference

10.5 Setup software

Temposonics offers Setup Software that is shipped with the level transmitter and is also available for download from www.temposonics.com. The Setup Software is to be used for installation, commissioning, and troubleshooting. For further details on how to use the setup software consult the Modbus Interface Manual (Part# 551700), the DDA Interface Manual (Part# 551701), and HART® Interface Manual (Part# 551702).

11. Spare Parts

Below are the spare parts list for the LP-Series show as the display, electronic module, sensing element, and flexible hose. Please contact Temposonics Technical Support with any questions.

Spare part	Part number	
Display	254732	
Output	Housing	Part number
HART® Single Loop	A, B, C, D, E	254731-1
HART® Dual Loop	A, B, C, D, E	254731-2
Modbus	A, B, C, D, E	254731-3
DDA	A, B, C, D, E	254731-4
HART® Single Loop	L	254731-5
HART® Dual Loop	L	254731-6

Output	Housing	Part number
Modbus	L	254731-7
DDA	L	254731-8
SIL Single Loop	A, B, C, D, E	254850-1
SIL Dual Loop	A, B, C, D, E	254850-2
SIL Single Loop	L	254850-5
SIL Dual Loop	L	254850-6

Sensing Element

Change third digit in Model Number from T to E.
For example, the sensing element for model number LPTME1N11B5FFIAU50000S is LPEME1N11B5FFIAU50000S.

Flexible Hose

Change third digit in Model Number from T to P.
For example, the replacement flexible hose for model number LPTME1N11B5FFIAU50000S is LPPME1N11B5FFIAU50000S.

12. Interface

CHAMBERED is available with multiple outputs including Modbus, DDA, and HART®. This Operation and Installation Manual includes all of these outputs. Each output has its own specialized Interface Manual that should be consulted for additional information on the specific output. For SIL consult the SIL Safety Manual, (Part #551851).

12.1 Modbus

Temposonics offers Modbus RTU over a RS485 half-duplex network. For additional information consult Modbus Interface Manual (Part #551700).

12.2 DDA

Temposonics offers DDA (Direct Digital Access) over a RS485 half-duplex network. For additional information consult DDA Interface Manual (Part #551701).

12.3 HART®

Temposonics offers HART® over a 4 to 20 mA signal. For additional information consult HART® Interface Manual (Part #551702).

13. Agency information

13.1 Approvals overview

The Notified Body is designated in the 13th digit of the model number and the Protection Method is designated in the 14th digit of the model number. These two digits of the model number specify the hazardous area approval that is provided with the selected level transmitter. Shown below are the detailed approval information for the NEC, CEC, IEC, ATEX, and UKCA approvals. Temposonics additionally has approvals under INMETRO, NEPSI, KC, CCoE, and CML (Japan). Please contact Temposonics with any questions about the hazardous approval needed.

Notified body	Protection method	Classification	Standard
C = CEC	I = Intrinsic Safety	Class I, Division 1, Groups ABCD T4 Class I, Zone 0, Ex ia IIC T4 Ga Ta = -50°C to 71°C IP65	CAN C22.2 No. 157-92:2012 CSA C22.2 No. 1010.1:2004 CAN/CSA C22.2 No. 60079-0:2011 CAN/CSA C22.2 No. 60079-11:2014 CAN/CSA C22.2 No. 60529:2005
	F = Explosionproof / Flame proof	Class I, Division 1, Groups BCD T6...T3 Ex db IIB+H2 T6...T3 Ga/Gb Ta = -40°C to 71°C IP65	CSA C22.2 No. 0.4-04:R2013 CSA C22.2 No. 0.5:R2012 CSA C22.2 No. 0-10:R2015 CSA C22.2 No. 30:R2012 CAN/CSA C22.2 No. 60079-0:2015 CAN/CSA C22.2 No. 60079-1:2016 CAN/CSA C22.2 No. 60079-26:2016 CAN/CSA C22.2 No. 61010.1:2012 CSA C22.2 No. 60529:R2010
E = ATEX	I = Intrinsic Safety	⊕ II 1 G Ex ia IIC T4 Ga Ta = -50°C to 71°C IP65	EN 60079-0:2018 EN 60079-11:2012 EN 60529:1991 + A1:2000
	F = Flame proof	⊕ II 1/2 G Ex db IIB+H2 T6...T3 Ga/Gb Ta = -40°C to 71°C IP65	EN 60079-0:2018+A11:2018 EN 60079-1:2014 EN 60079-26:2015 EN 60529:1991 + A2:2013
F = NEC	I = Intrinsic Safety	Class I, Division 1, Groups ABCD T4 Class I, Zone 0, AEx ia IIC T4 Ga Ta = -50°C to 71°C IP65	FM 3600:2011 FM 3610:2010 FM 3810:2005 ANSI/ISA 60079-0:2013 ANSI/ISA 60079-11:2014 ANSI/IEC 60529:2004
	F = Explosionproof / Flame proof	Class I, Division 1, Groups ABCD T6...T3 Class I, Division 1, Groups BCD T6...T3 Class I, Zone 0/1, AEx db IIB+H2 T6...T3 Ga/Gb Ta = -40°C to 71°C IP65	FM 3600:2011 FM 3615:2006 FM 3810:2005 ANSI/ISA 60079-0:2013 ANSI/UL 60079-1:2015 ANSI/UL 60079-26:2017 ANSI/IEC 60529:2004
I = IEC	I = Intrinsic Safety	Ex ia IIC T4 Ga Ta = -50°C to 71°C IP65	IEC 60079-0:2011 IEC 60079-11:2011
	F = Flame proof	Ex db IIB+H2 T6...T3 Ga/Gb Ta = -40°C to 71°C IP65	IEC 60079-0:2007-10 IEC 60079-1:2007-04 IEC 60079-26:2014-10 IEC 60529:2013
B = INMETRO	I = Intrinsic Safety	Ex ia IIC T4 Ga Ta = -50°C to 71°C IP65	ABNT NBR IEC 60079-0 ABNT NBR IEC 60079-11 ABNT NBR IEC 60529
	F = Flameproof	Ex db IIB+H2 T6...T3 Ga/Gb Ta = -40°C to 71°C IP65	ABNT NBR IEC 60079-0 ABNT NBR IEC 60079-1 ABNT NBR IEC 60079-26 ABNT NBR IEC 60529

Table 6: Agency approvals, part 1

Continued on next page...

Level Plus® CHAMBERED

Operation Manual

Notified body	Protection method	Classification	Standard
N = NEPSI	I = Intrinsic Safety	Ex ia IIC T4 Ga Ta = -50°C to 71°C IP65	GB 3836.1-2010 GB 3836.4-2010 GB 3836.20-2010
	F = Flameproof	Ex db IIB+H2 T6...T3 Ga/Gb Ta = -40°C to 71°C IP65	GB 3836.1-2010 GB 3836.2-2010
C = CCoE/ PESO	I = Intrinsic Safety	Ex ia IIC T4 Ga Ta = -50°C to 71°C IP65	IEC 60079-0:2011 IEC 60079-11:2011 Petroleum Rules 2002
	F = Flameproof	Ex db IIB+H2 T6...T3 Ga/Gb Ta = -40°C to 71°C IP65	IEC 60079-0:2007-10 IEC 60079-1:2007-04 IEC 60079-26:2014-10 IEC 60529:2013 Petroleum Rules 2002
T = CML/TIIS	I = Intrinsic Safety	Ex ia IIC T4 Ga Ta = -50°C to 71°C IP65	IEC 60079-0:2011 IEC 60079-11:2011
	F = Flameproof	Ex db IIB+H2 T6...T3 Ga/Gb Ta = -40°C to 71°C IP65	IEC 60079-0:2007-10 IEC 60079-1:2007-04 IEC 60079-26:2014-10 IEC 60529:2013
K = KC	I = Intrinsic Safety	Ex ia IIC T4 Ga Ta = -50°C to 71°C IP65	ABNT NBR IEC 60079-0 ABNT NBR IEC 60079-11 ABNT NBR IEC 60529
	F = Flameproof	Ex db IIB+H2 T6...T3 Ga/Gb Ta = -40°C to 71°C IP65	ABNT NBR IEC 60079-0 ABNT NBR IEC 60079-1 ABNT NBR IEC 60079-26 ABNT NBR IEC 60529
U = UKCA	I = Intrinsic Safety	Ex ia IIC T4 Ga Ta = -50°C to 71°C IP65	BS 60079-0:2018 BS 60079-11:2012 BS 60529:1991+A2:2013
	F = Flameproof	Ex db IIB+H2 T6...T3 Ga/Gb Ta = -40°C to 71°C IP65	BS 60079-0:2018 BS 60079-1:2014 BS 60079-26:2015 BS 60529:1991+A2:2013

Table 7: Agency approvals, part 2

13.2 Certificates

Downloadable copies of all certificates are located at www.temposonics.com and can be downloaded on the product specific landing page. If there is any difficulty in obtaining the certificates from the web contact Temposonics Technical Support and they will be sent electronically.

13.3 FM

13.3.1 FM IS

13.3.1.1 Specific Conditions of Safe Use

1. When EPL Ga or Da is required, parts of the equipment containing light metals (Aluminum or Titanium) shall be protected from impact so that impact or friction sparks cannot occur, taking into account rare malfunction. Measures to prevent impact or friction sparks when using the equipment containing light metals include but are not limited to
 - Mounting the probe vertically
 - No mechanical agitation shall be used
 - Use of stilling wells to mitigate effect of agitation.
 - Limit rate of change of level to values such that friction sparks

cannot occur

2. The maximum permitted ambient temperature of the Level Plus Digital/Analog Level Transmitter is 71 °C. To avoid the effects of process temperature and other thermal effects care shall be taken to ensure the surrounding ambient and the ambient inside the transmitter housing does not exceed 71°C
3. Warning: The equipment contains non-metallic enclosure and process parts. To prevent the risk of electrostatic sparking, the non-metallic surface should only be cleaned with a damp cloth. Painted surface of the equipment may store electrostatic charge and become a source of ignition in applications with a low relative humidity <~30% relative humidity where the painted surface is relatively free of surface contamination such as dirt, dust or oil. Cleaning of the painted surface should only be done with a damp cloth.
4. The applicable temperature class, process temperature range and ambient temperature range of the equipment is as follows;
 - T3 with Process Temperature Range of -40°C to 150°C
 - T4 with Process Temperature Range of -40°C to 135°C
 - T5 with Process Temperature Range of -40°C to 100°C
 - T6 with Process Temperature Range of -40°C to 85°C
 - Ambient Temperature Range $-40^{\circ}\text{C} < T_a < 71^{\circ}\text{C}$

13.3.1.2 Labels

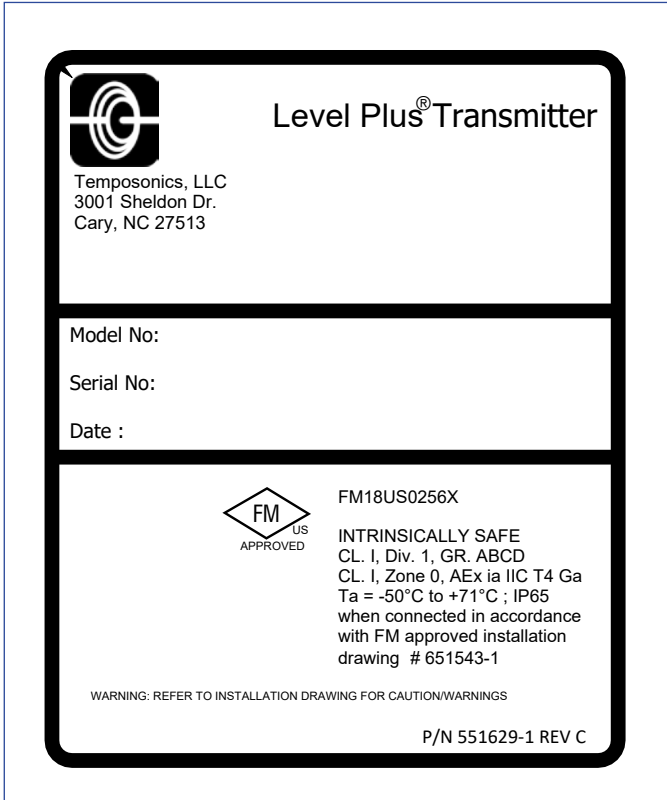

Fig. 14: Intrinsically Safe FM label, Modbus, or DDA, NEMA Housing

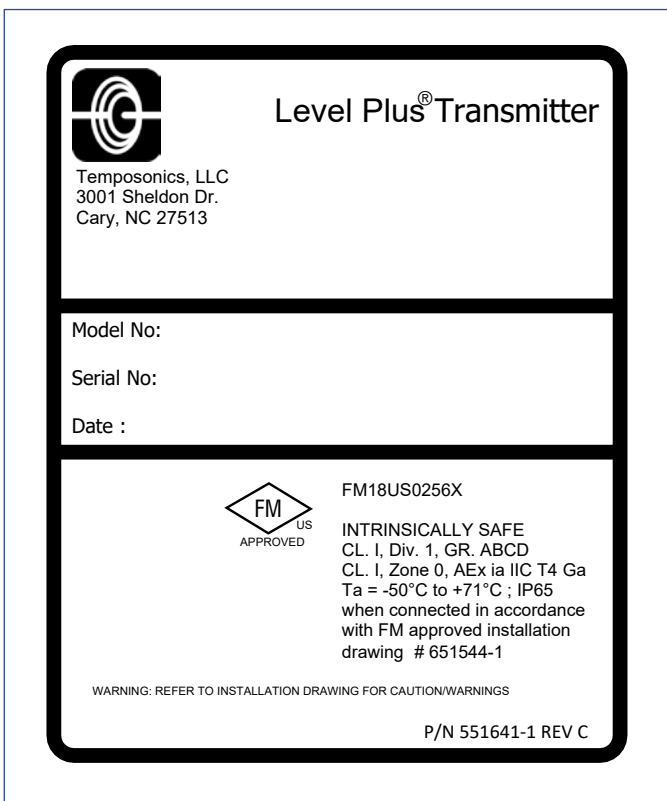

Fig. 15: Intrinsically Safe FM label, HART®, NEMA Housing

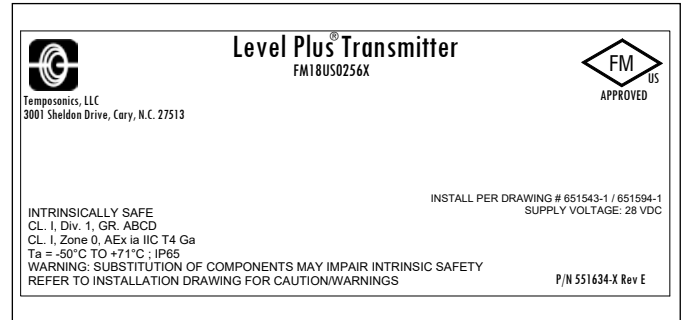

Fig. 16: Intrinsically Safe FM label, Modbus or DDA, Single or Dual Cavity Housing

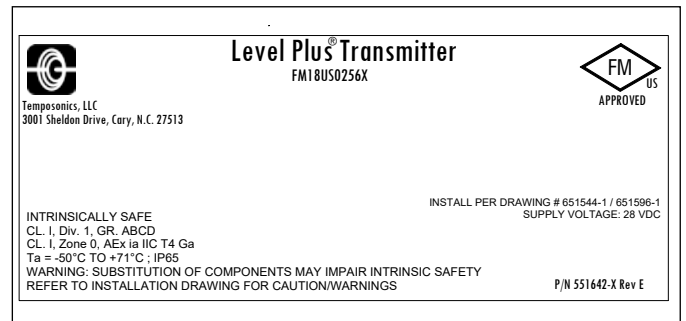

Fig. 17: Intrinsically Safe FM label, HART®, Single or Dual Cavity Housing

13.3.1.3 Installation drawing

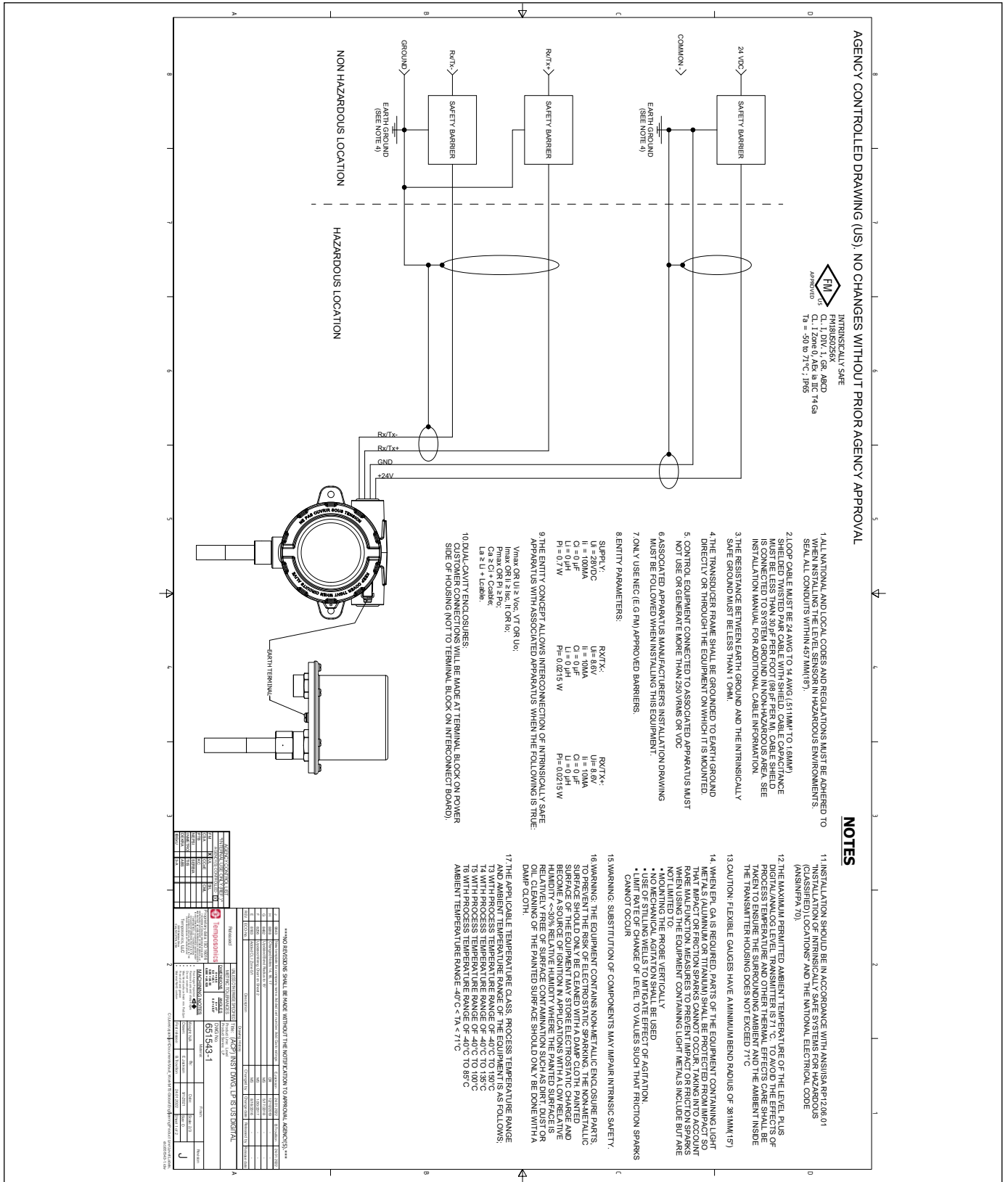

Fig. 18: Intrinsically Safe FM installation drawing, Modbus and DDA, Page 1

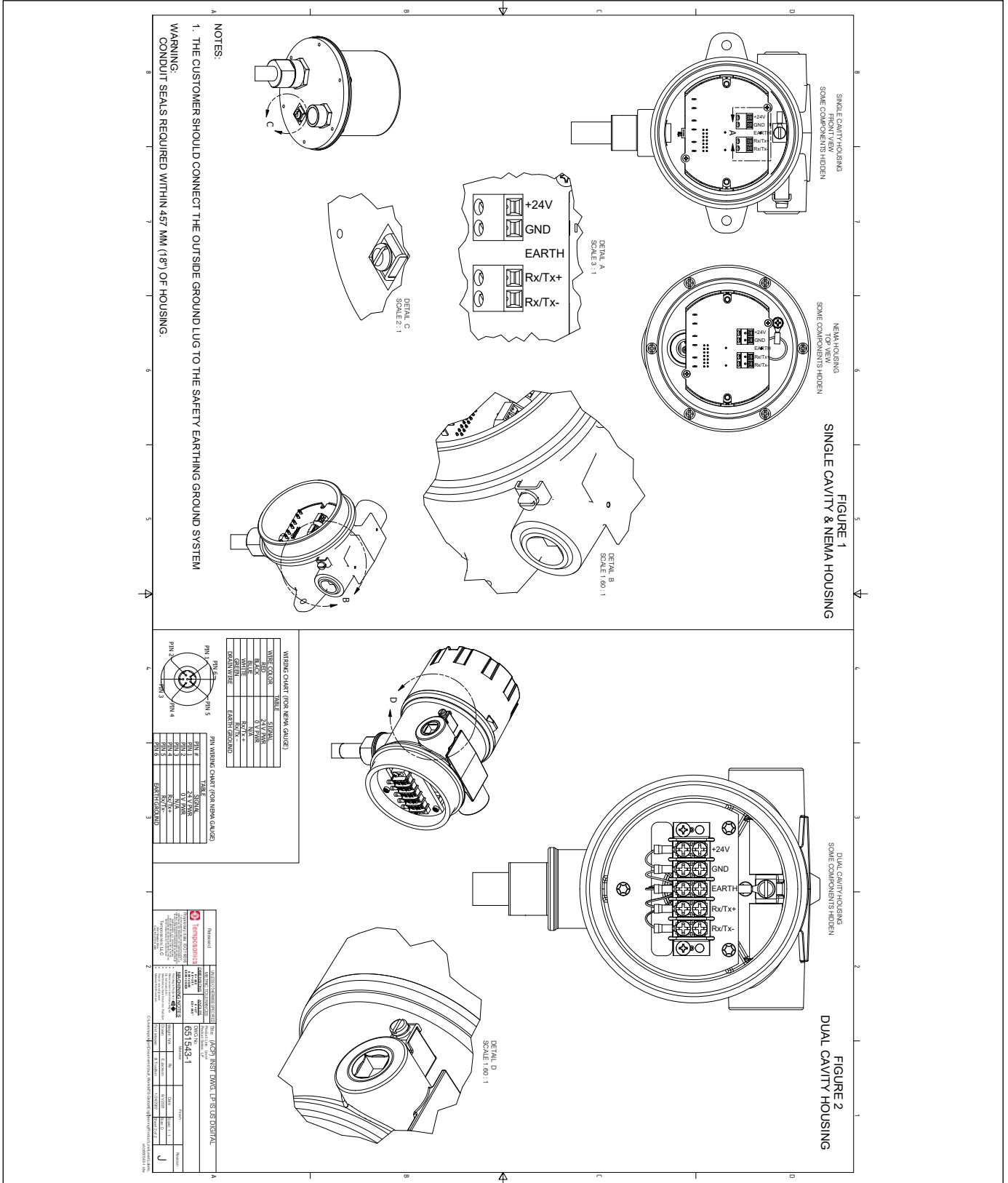

Fig. 19: Intrinsically Safe FM installation drawing, Modbus and DDA, Page 2

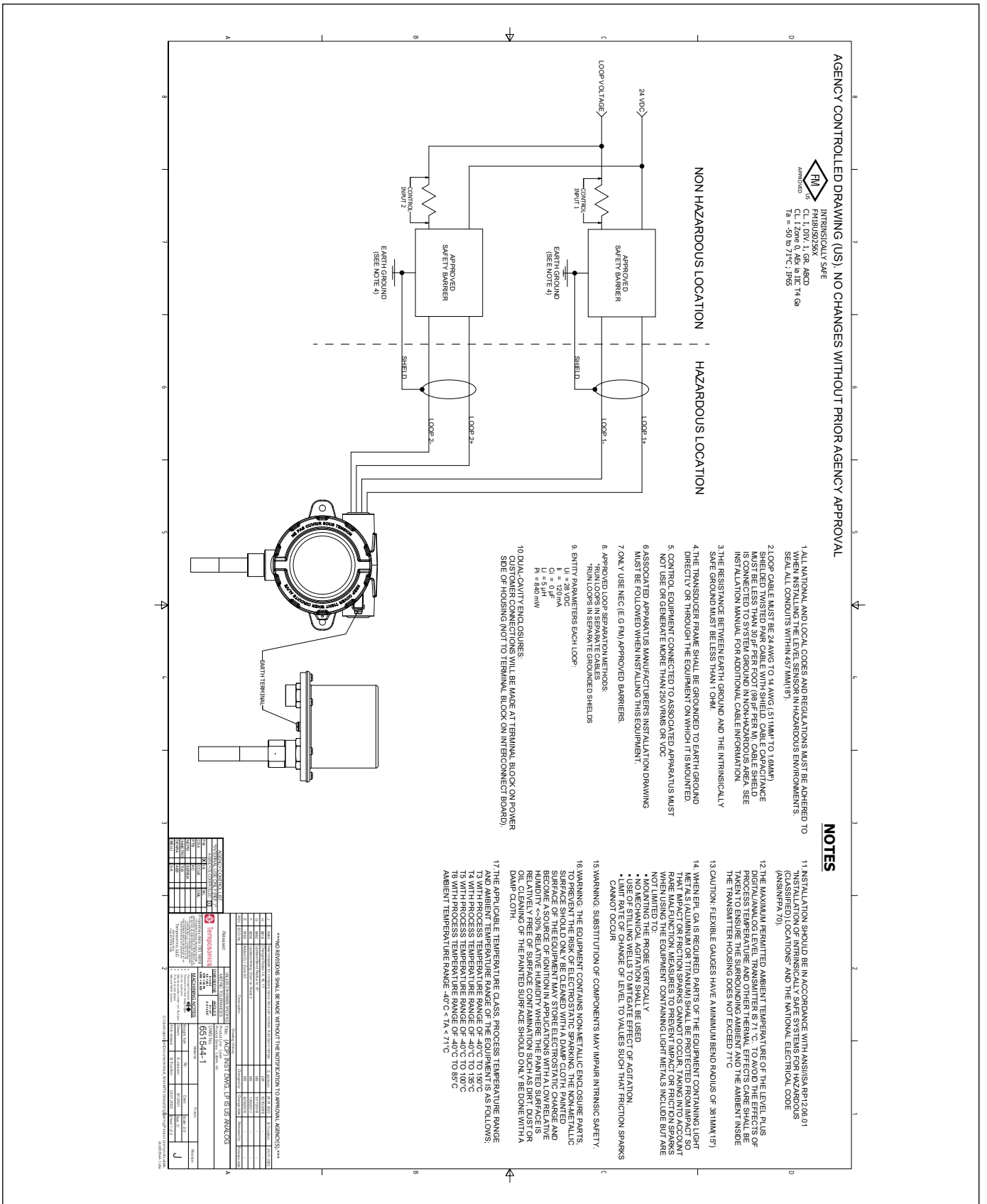

Fig. 20: Intrinsically Safe FM installation drawing, HART®, Page 1

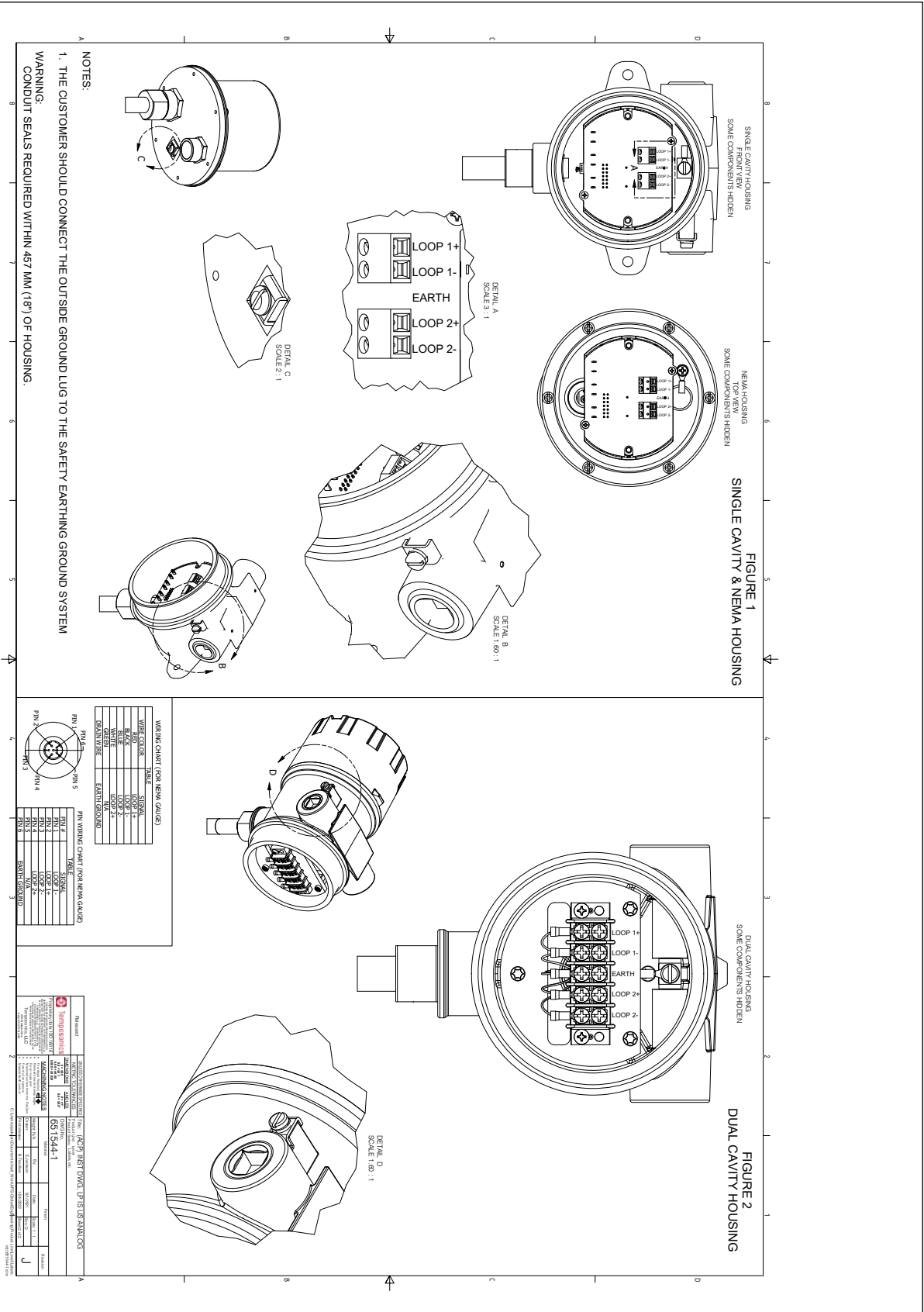

Fig. 21: Intrinsically Safe FM installation drawing, HART®, Page 2

13.3.2 FM XP

13.3.2.1 Specific Conditions of Safe Use

- Warning: The equipment contains non-metallic enclosure and process parts. To prevent the risk of electrostatic sparking, the non-metallic surface should only be cleaned with a damp cloth. Painted surface of the equipment may store electrostatic charge and become a source of ignition in applications with a low relative humidity <~30% relative humidity where the painted surface is relatively free of surface contamination such as dirt, dust or oil. Cleaning of the painted surface should only be done with a damp cloth.
- Cables shall be rated > 5°C above maximum ambient temperature.
- To maintain the ingress protection rating of IP65, Teflon tape (3 wraps) or pipe dope shall be used. Refer to Installation Instructions.
- The equipment can be installed in the boundary wall between a Zone 0 area and the less hazardous area, Zone 1. In this configuration, the process connection is installed in a Zone 0 area, while the transmitter housing is installed in a Zone 1 area. Refer to installation instructions.
- Flexible gauges have a minimum bend diameter of 381mm (15 inches).
- Flamepaths not for repair.
- The applicable temperature class, process temperature range and ambient temperature range of the equipment is as follows;
 - T3 with Process Temperature Range of -40°C to 150°C
 - T4 with Process Temperature Range of -40°C to 135°C
 - T5 with Process Temperature Range of -40°C to 100°C
 - T6 with Process Temperature Range of -40°C to 85°C
 - Ambient Temperature Range -40°C < Ta < 71°C
- When mounting on a MLG (magnetic level gauge) make sure the electronic head and pressure barrier have a minimum spacing of 5 inches. See Installation Manual for detail.
- When EPL Ga or Da is required, parts of the equipment containing light metals (Aluminum or Titanium) shall be protected from impact so that impact or friction sparks cannot occur, taking into account rare malfunction. Measures to prevent impact or friction sparks when using the equipment containing light metals include but are not limited to:
 - Mounting the probe vertically
 - No mechanical agitation shall be used
 - Use of stilling wells to mitigate effect of agitation.
 - Limit rate of change of level to values such that friction sparks cannot occur

13.3.2.2 Labels

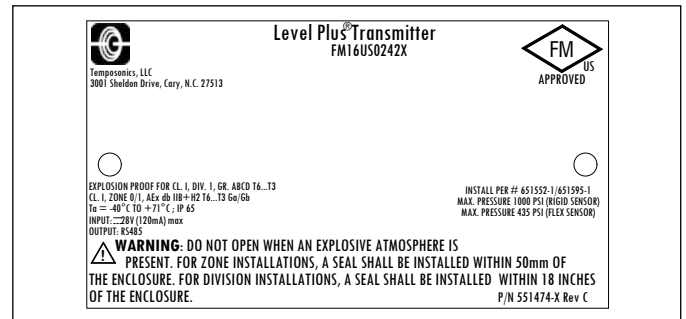

Fig. 22: Explosion proof, FM label, Modbus or DDA Housing Option G, H, or L

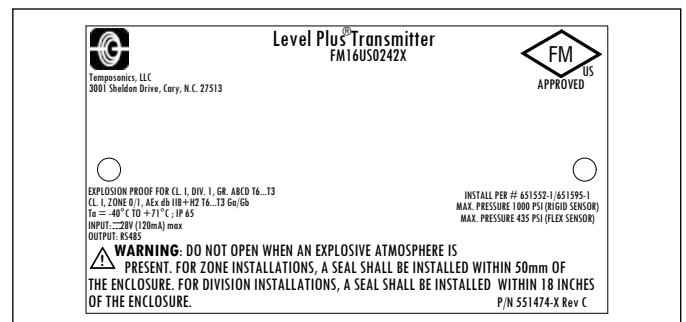

Fig. 23: Explosion proof, FM label, Modbus or DDA, Housing Option D, E

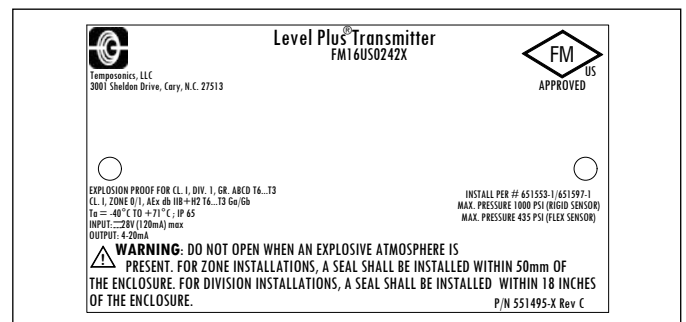

Fig. 24: Explosion proof, FM label, HART®, Housing Option G, H, or L

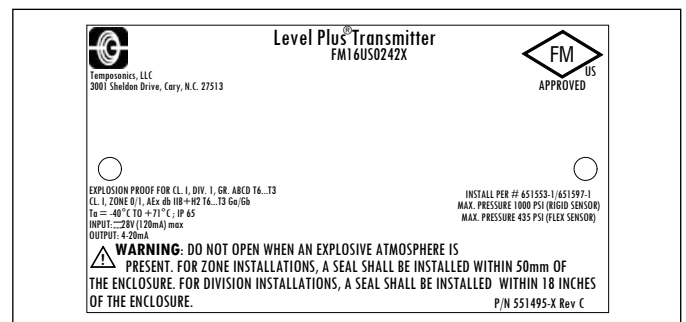

Fig. 25: Explosion proof, FM label, HART®, Housing Option D, E

13.3.2.3 Installation Drawing

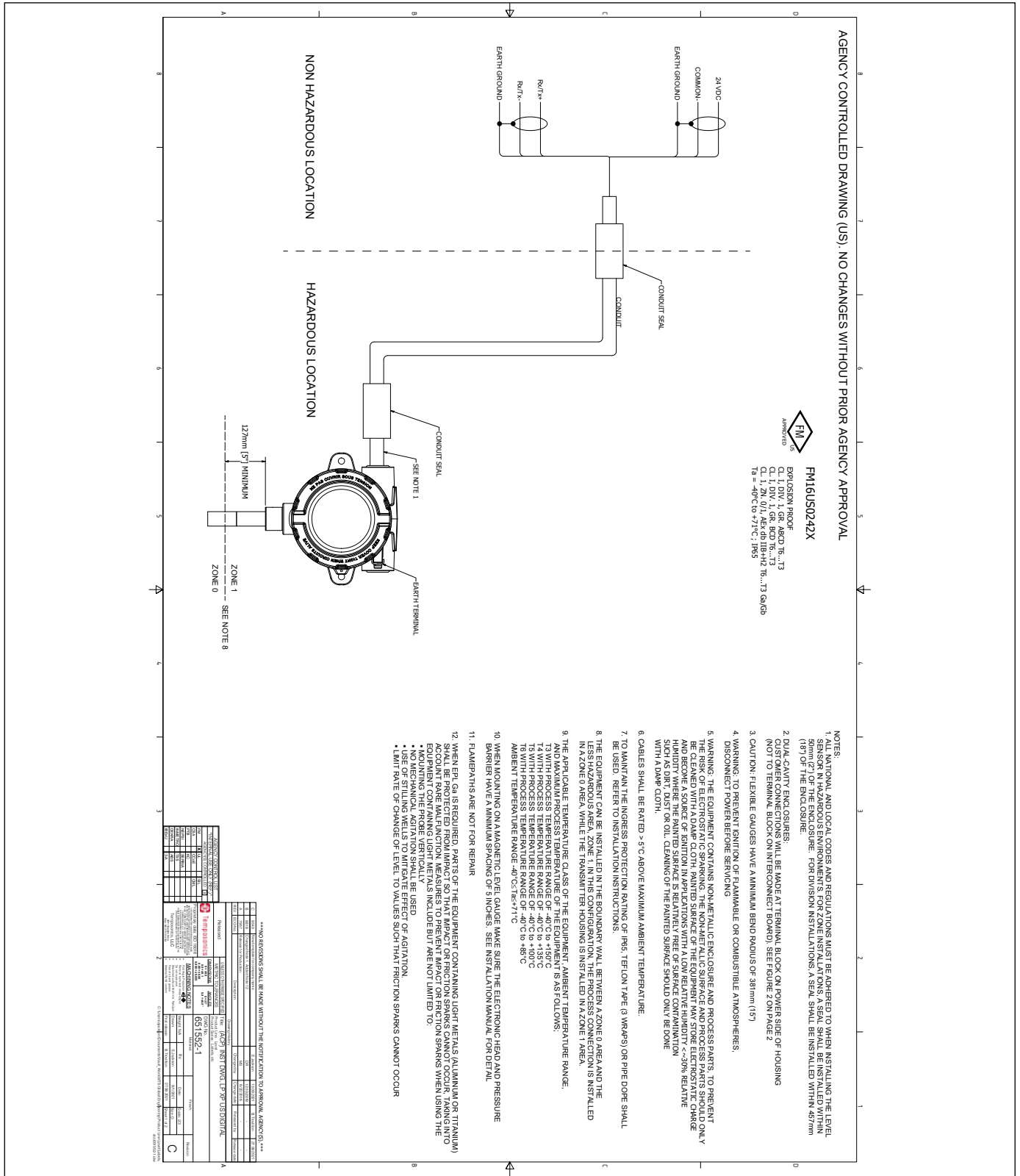

Fig. 26: Explosion proof, FM Installation Drawing, Modbus and DDA, Page 1

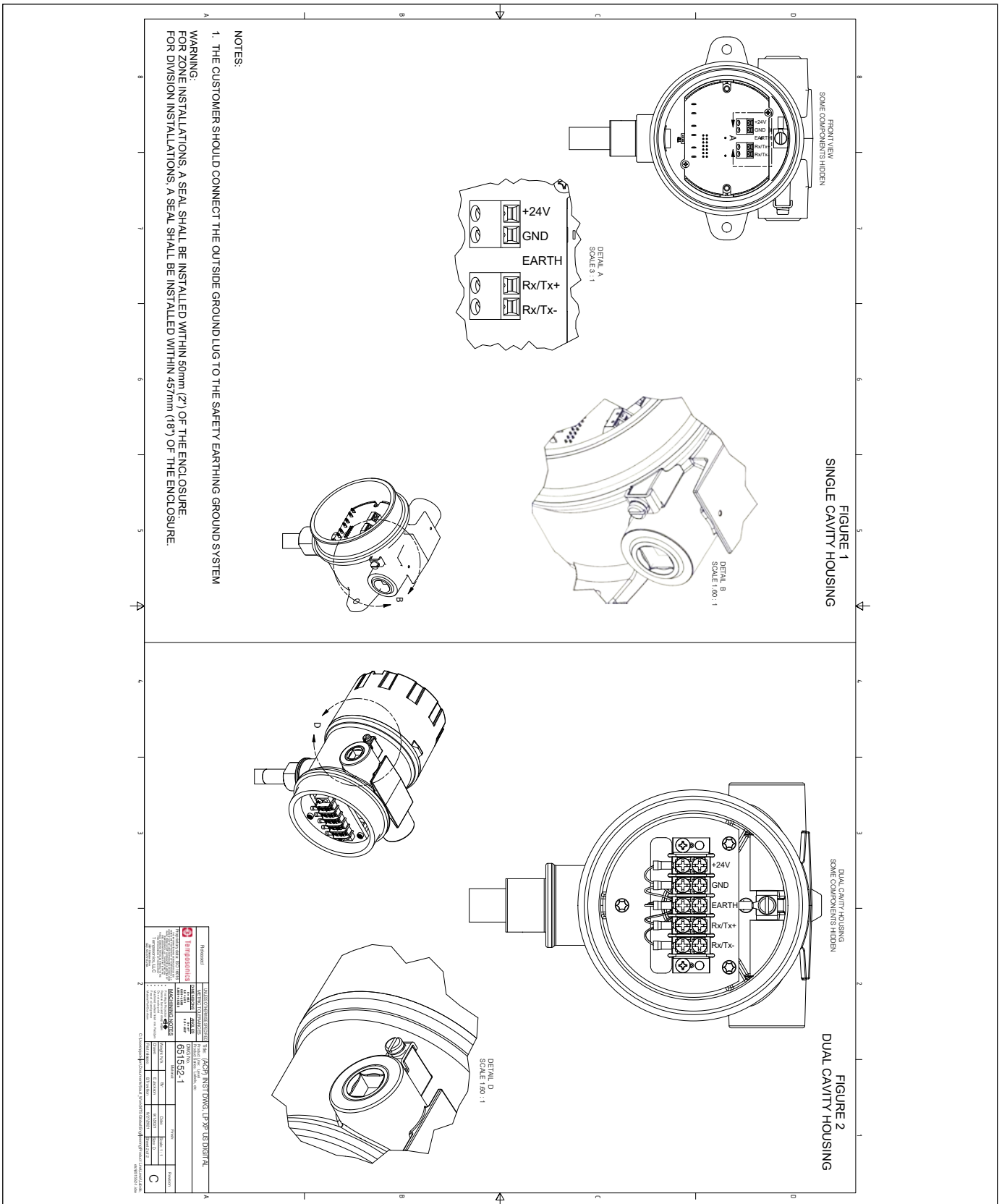

Fig. 27: Explosion proof, FM Installation Drawing, Modbus and DDA, Page 2

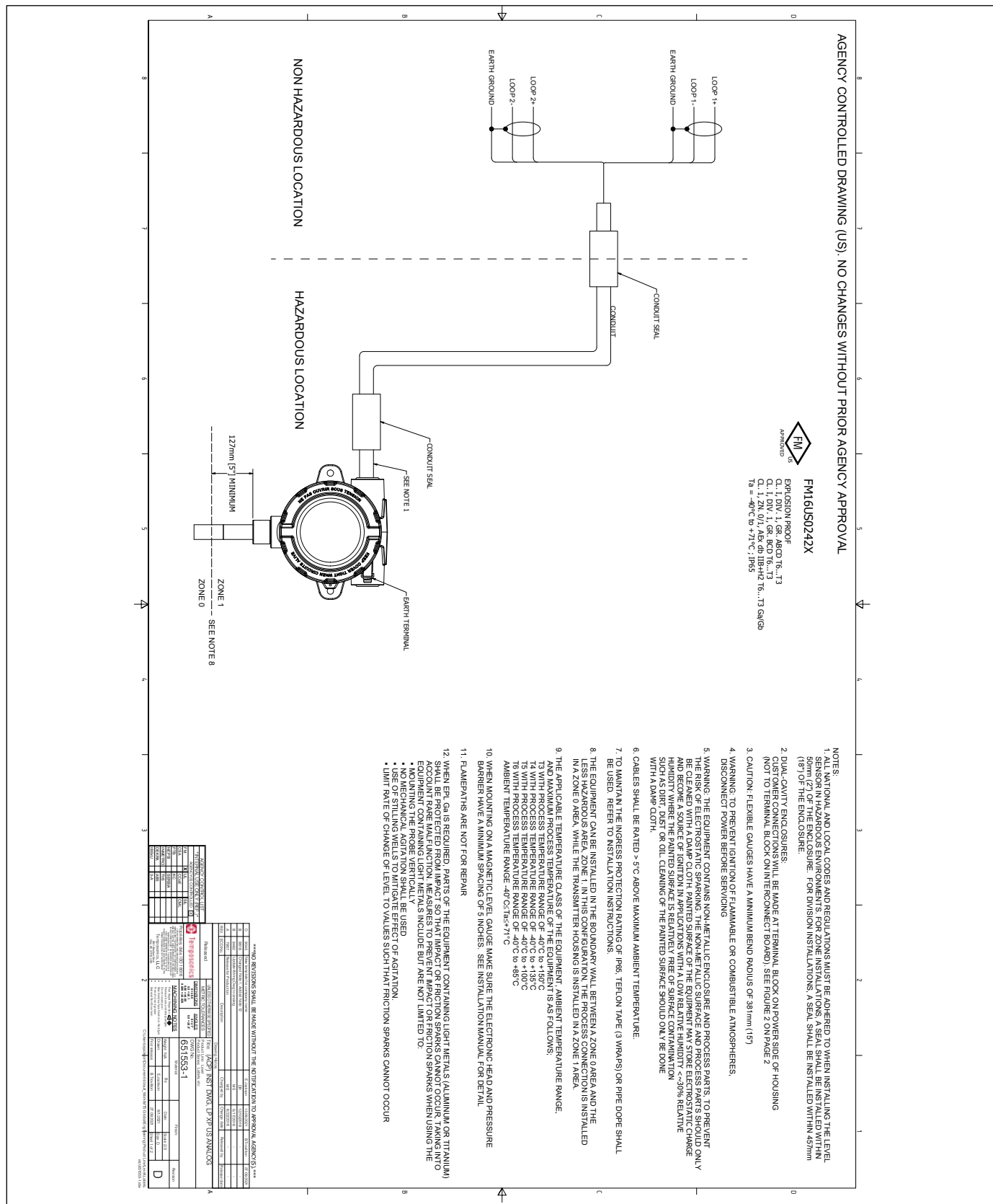

Fig. 28: Explosion proof, FM Installation Drawing, HART®, Page 1

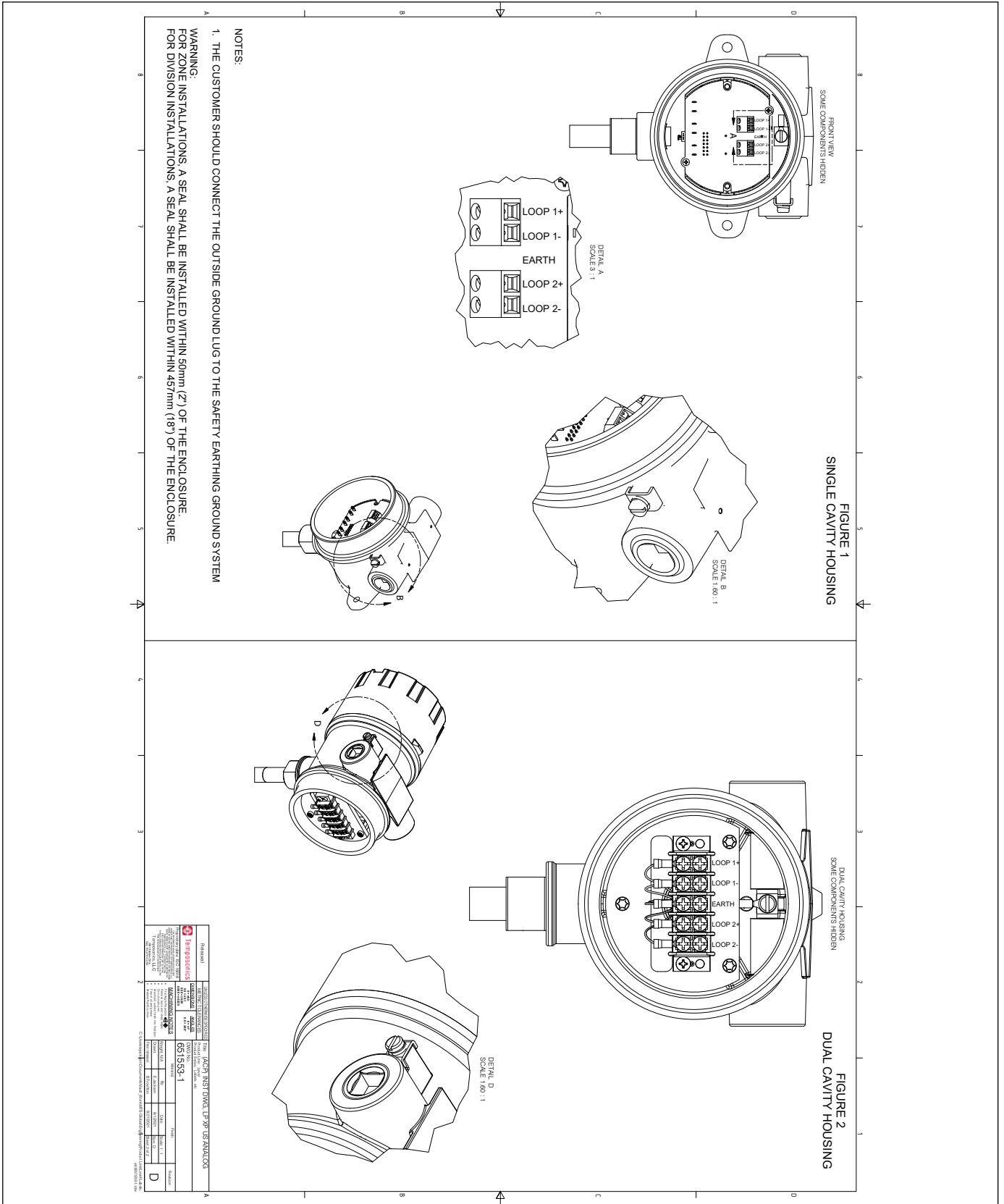

Fig. 29: Explosion proof, FM Installation Drawing, HART®, Page 2

13.4 FMC

13.4.1 FMC IS

13.4.1.1 Specific conditions of safe use

1. When EPL Ga or Da is required, parts of the equipment containing light metals (Aluminum or Titanium) shall be protected from impact so that impact or friction sparks cannot occur, taking into account rare malfunction. Measures to prevent impact or friction sparks when using the equipment containing light metals include but are not limited to:
 - Mounting the probe vertically
 - No mechanical agitation shall be used
 - Use of stilling wells to mitigate effect of agitation.
 - Limit rate of change of level to values such that friction sparks cannot occur
2. The maximum permitted ambient temperature of the Level Plus Digital/Analog Level Transmitter is 71 °C. To avoid the effects of process temperature and other thermal effects care shall be taken to ensure the surrounding ambient and the ambient inside the transmitter housing does not exceed 71°C
3. Warning: The equipment contains non-metallic enclosure and process parts. To prevent the risk of electrostatic sparking, the non-metallic surface should only be cleaned with a damp cloth. Painted surface of the equipment may store electrostatic charge and become a source of ignition in applications with a low relative humidity <~30% relative humidity where the painted surface is relatively free of surface contamination such as dirt, dust or oil. Cleaning of the painted surface should only be done with a damp cloth.
4. The applicable temperature class, process temperature range and ambient temperature range of the equipment is as follows;
 - T3 with Process Temperature Range of -40°C to 150°C
 - T4 with Process Temperature Range of -40°C to 135°C
 - T5 with Process Temperature Range of -40°C to 100°C
 - T6 with Process Temperature Range of -40°C to 85°C
 - Ambient Temperature Range -40°C < Ta < 71°C

13.4.1.2 Labels

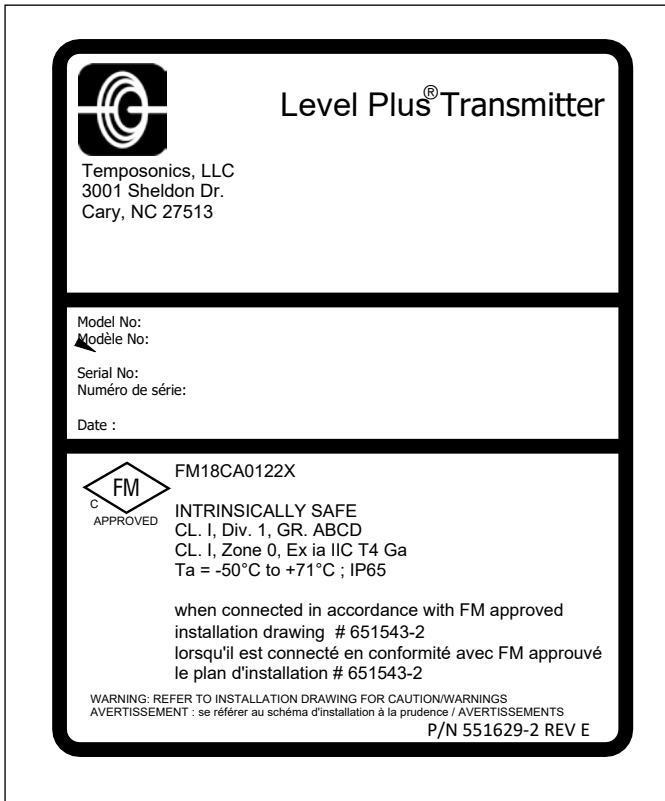

Fig. 30: Intrinsically Safe FMC label, Modbus and DDA, NEMA Housing

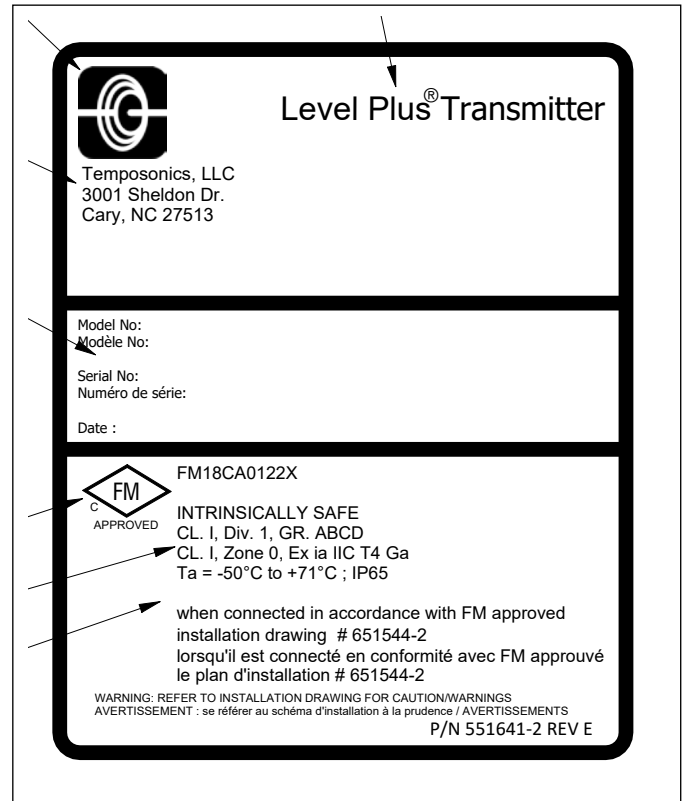

Fig. 31: Intrinsically Safe FMC label, HART®, NEMA Housing

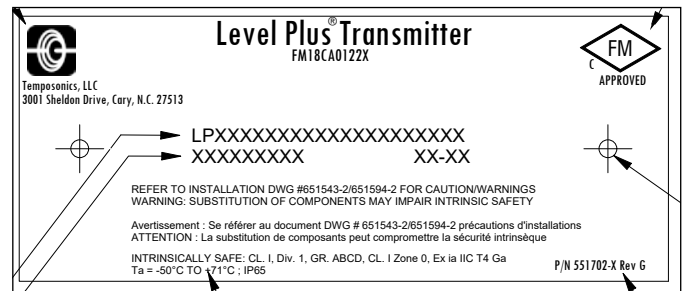

Fig. 32: Intrinsically Safe FMC label, Modbus and DDA, Single and Dual Cavity Housing

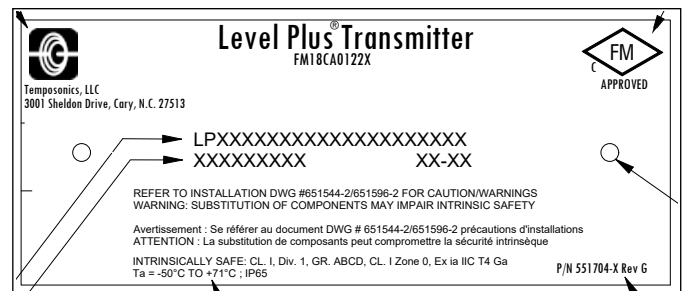

Fig. 33: Intrinsically Safe FMC label, HART®, Single and Dual Cavity Housing

13.4.1.3 Installation Drawing

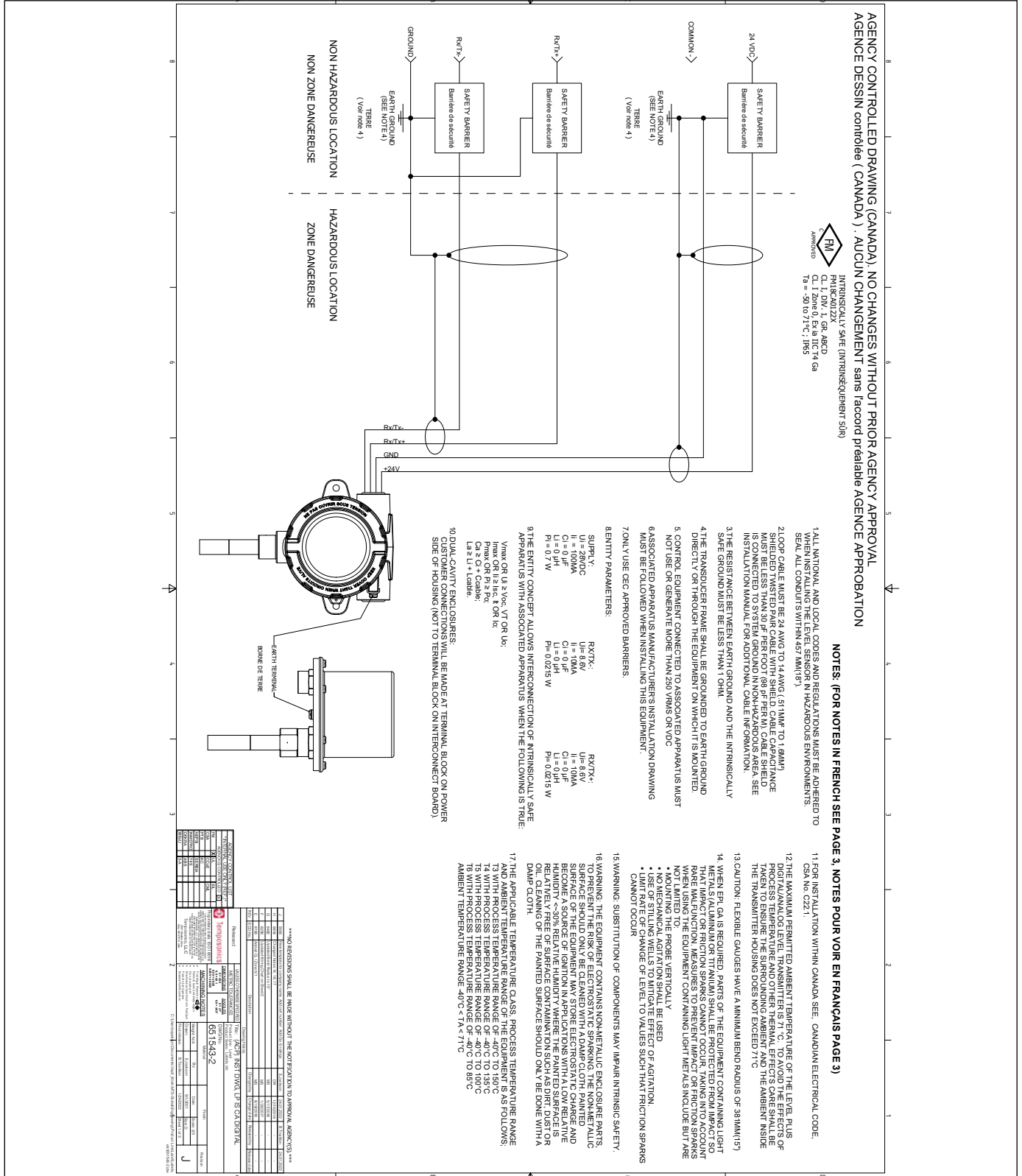

Fig. 34: Intrinsically Safe FMC installation drawing, Modbus and DDA, Page 1

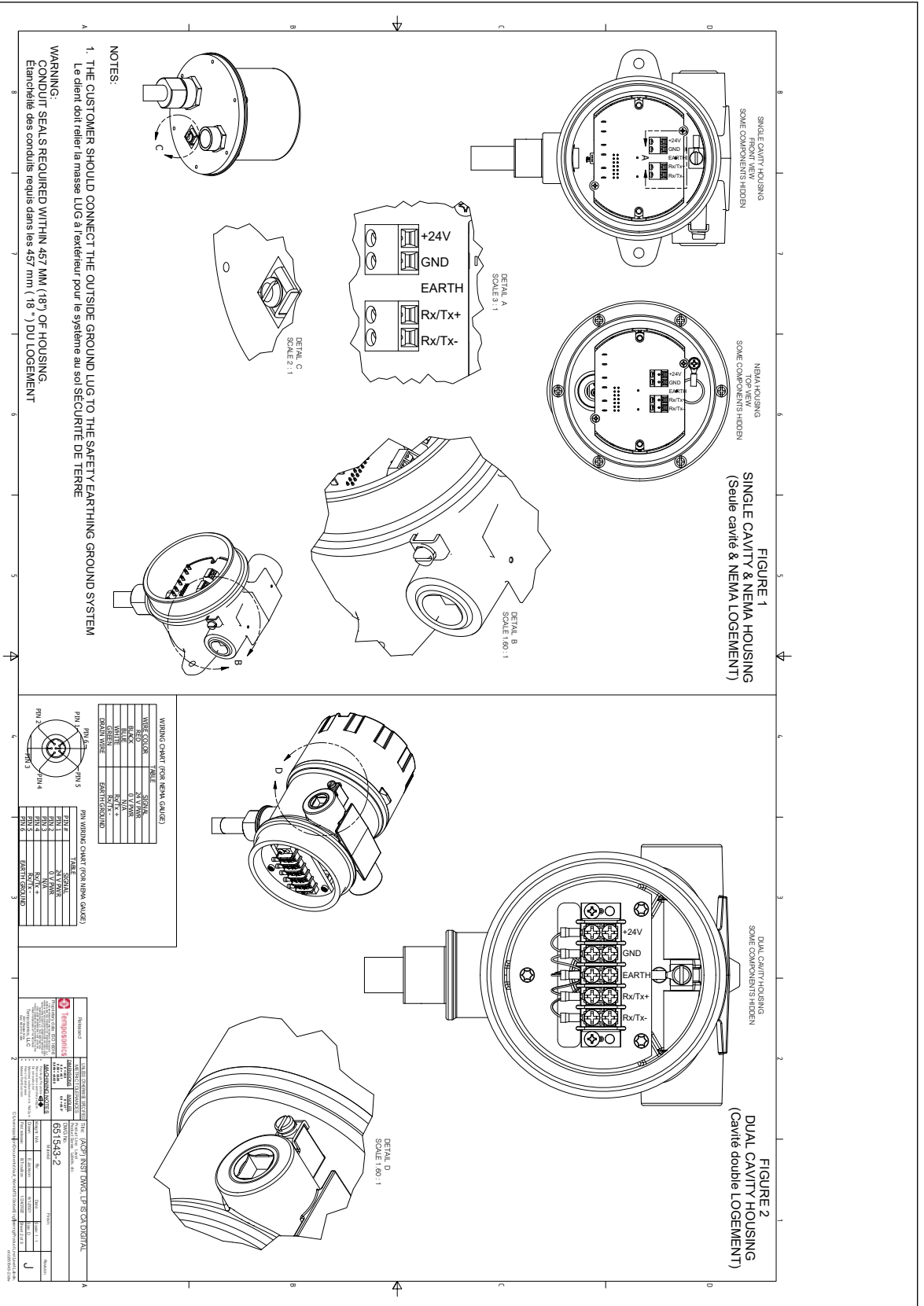

Fig. 35: Intrinsically Safe FMC installation drawing, Modbus and DDA, Page 2

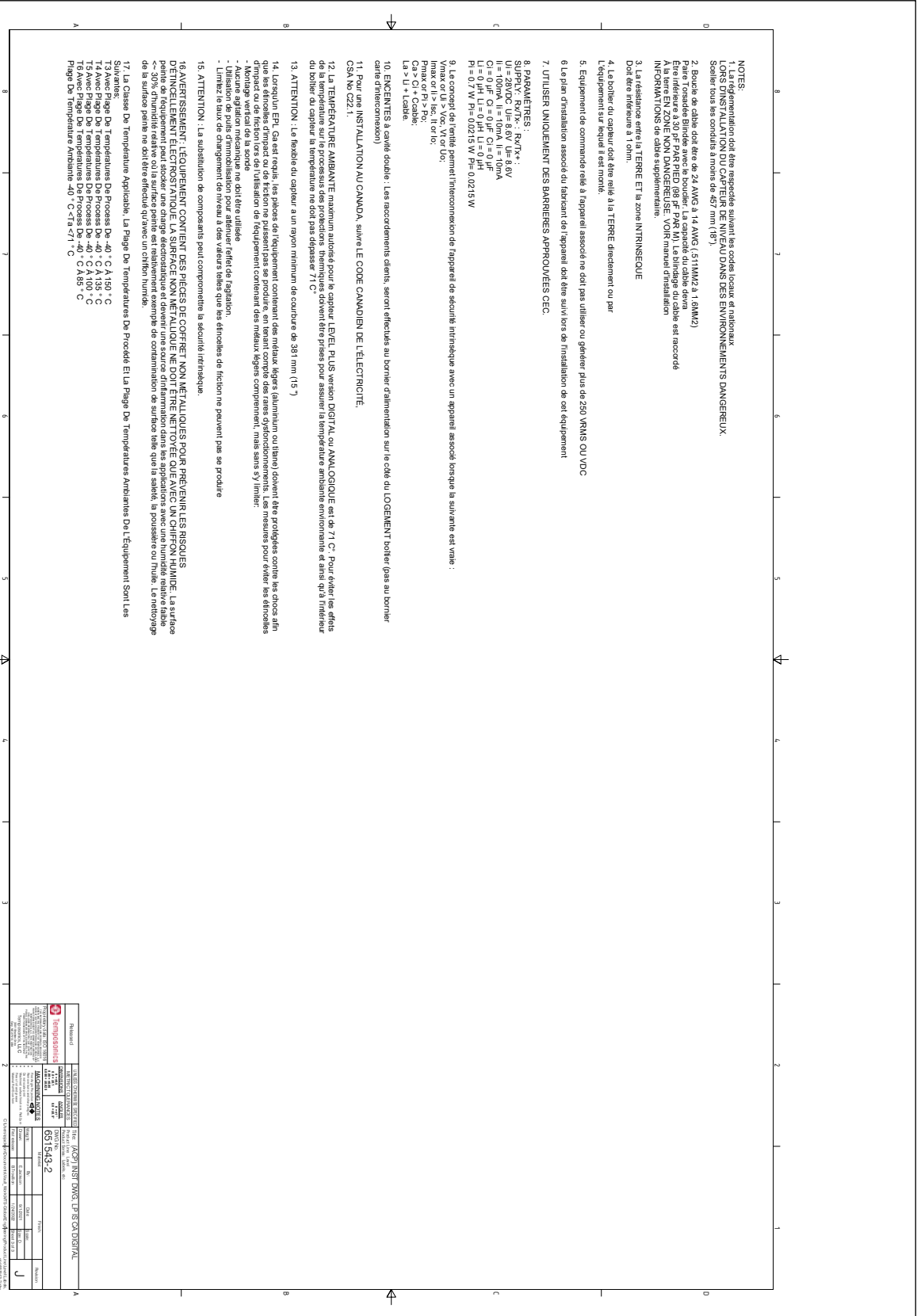

Fig. 36: Intrinsically Safe FMC installation drawing, Modbus and DDA, Page 3

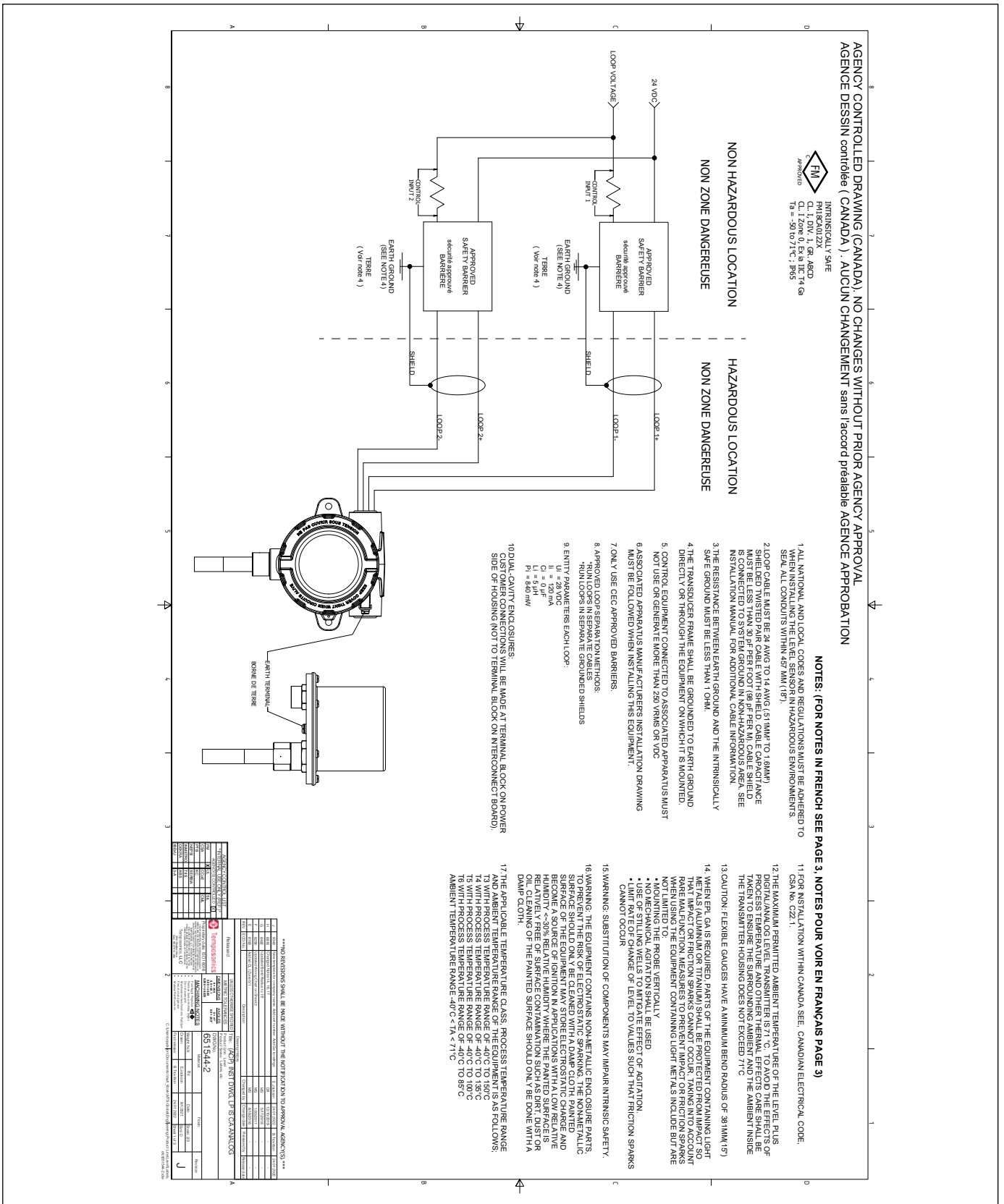

Fig. 37: Intrinsically Safe FMC installation drawing, HART®, Page 1

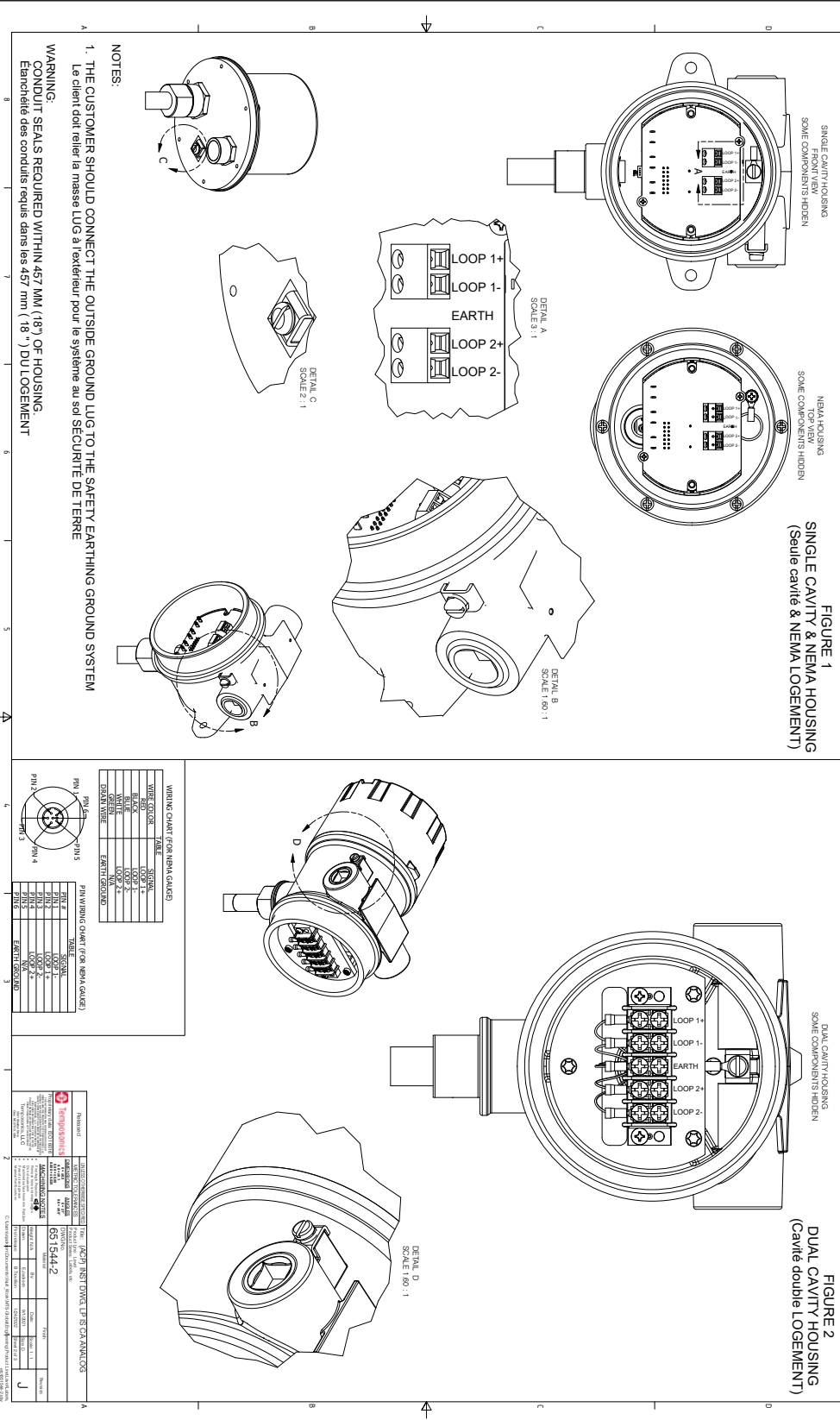

Fig. 38: Intrinsically Safe FMC installation drawing, HART®, Page 2



Fig. 39: Intrinsically Safe FMC installation drawing, HART®, Page 3

13.4.2 FMC XP

13.4.2.1 Specific Conditions of Safe Use

- Warning: The equipment contains non-metallic enclosure and process parts. To prevent the risk of electrostatic sparking, the non-metallic surface should only be cleaned with a damp cloth. Painted surface of the equipment may store electrostatic charge and become a source of ignition in applications with a low relative humidity <~30% relative humidity where the painted surface is relatively free of surface contamination such as dirt, dust or oil. Cleaning of the painted surface should only be done with a damp cloth.
- Cables shall be rated > 5°C above maximum ambient temperature.
- To maintain the ingress protection rating of IP65, Teflon tape (3 wraps) or pipe dope shall be used. Refer to Installation Instructions.
- The equipment can be installed in the boundary wall between an EPL Ga area and the less hazardous area, EPL Gb. In this configuration, the process connection is installed in EPL Ga, while the transmitter housing is installed in EPL Gb. Refer to installation instructions.
- Flexible gauges have a minimum bend diameter of 381mm (15 inches).
- Flamepaths not for repair.
- The applicable temperature class, process temperature range and ambient temperature range of the equipment is as follows;
 - T3 with Process Temperature Range of -40°C to 150°C
 - T4 with Process Temperature Range of -40°C to 135°C
 - T5 with Process Temperature Range of -40°C to 100°C
 - T6 with Process Temperature Range of -40°C to 85°C
 - Ambient Temperature Range -40°C < Ta < 71°C
- When mounting on a MLG (magnetic level gauge) make sure the electronic head and pressure barrier have a minimum spacing of 5 inches. See Installation Manual for detail.
- When EPL Ga or Da is required, parts of the equipment containing light metals (Aluminum or Titanium) shall be protected from impact so that impact or friction sparks cannot occur, taking into account rare malfunction. Measures to prevent impact or friction sparks when using the equipment containing light metals include but are not limited to:
 - Mounting the probe vertically
 - No mechanical agitation shall be used
 - Use of stilling wells to mitigate effect of agitation.
 - Limit rate of change of level to values such that friction sparks cannot occur

13.4.2.2 Labels

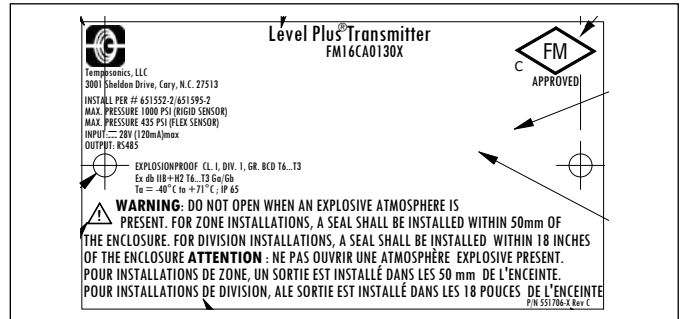

Fig. 40: Explosion proof, FMC label, Modbus or DDA Housing Option G, H, or L

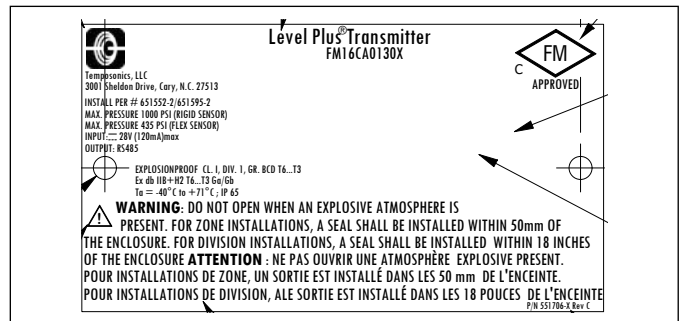

Fig. 41: Explosion proof, FMC label, Modbus or DDA, Housing Option D, E

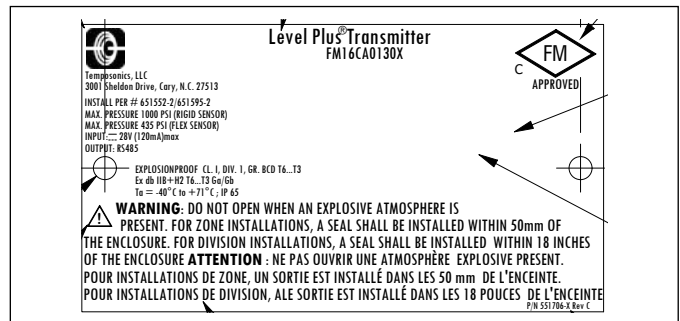

Fig. 42: Explosion proof, FMC label, HART®, Housing Option G, H, or L

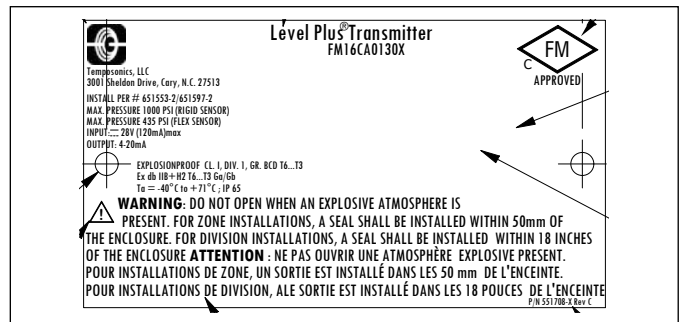

Fig. 43: Explosion proof, FMC label, HART®, Housing Option D, E

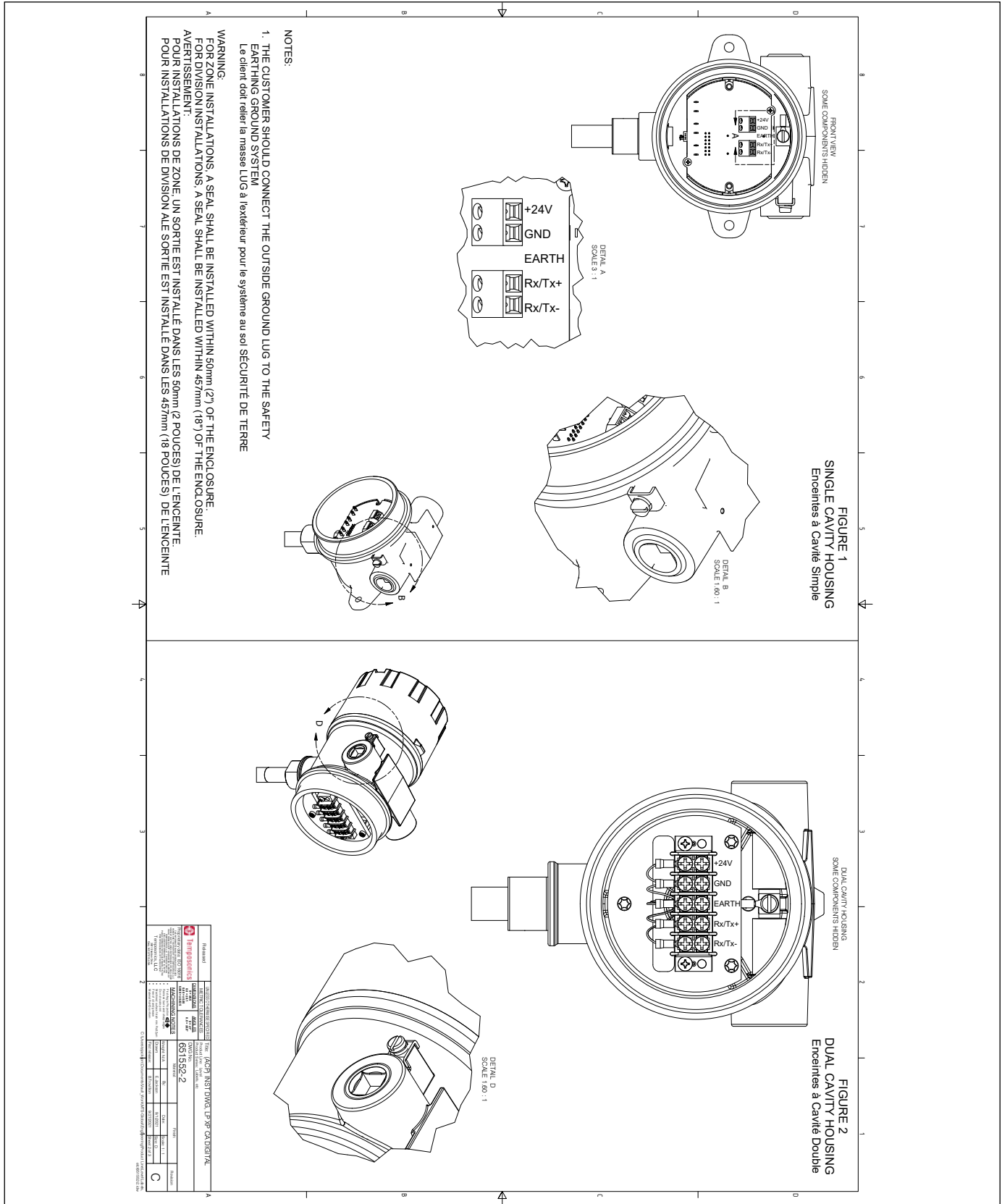

Fig. 45: Explosion proof, FMC Installation Drawing, Modbus and DDA, Page 2

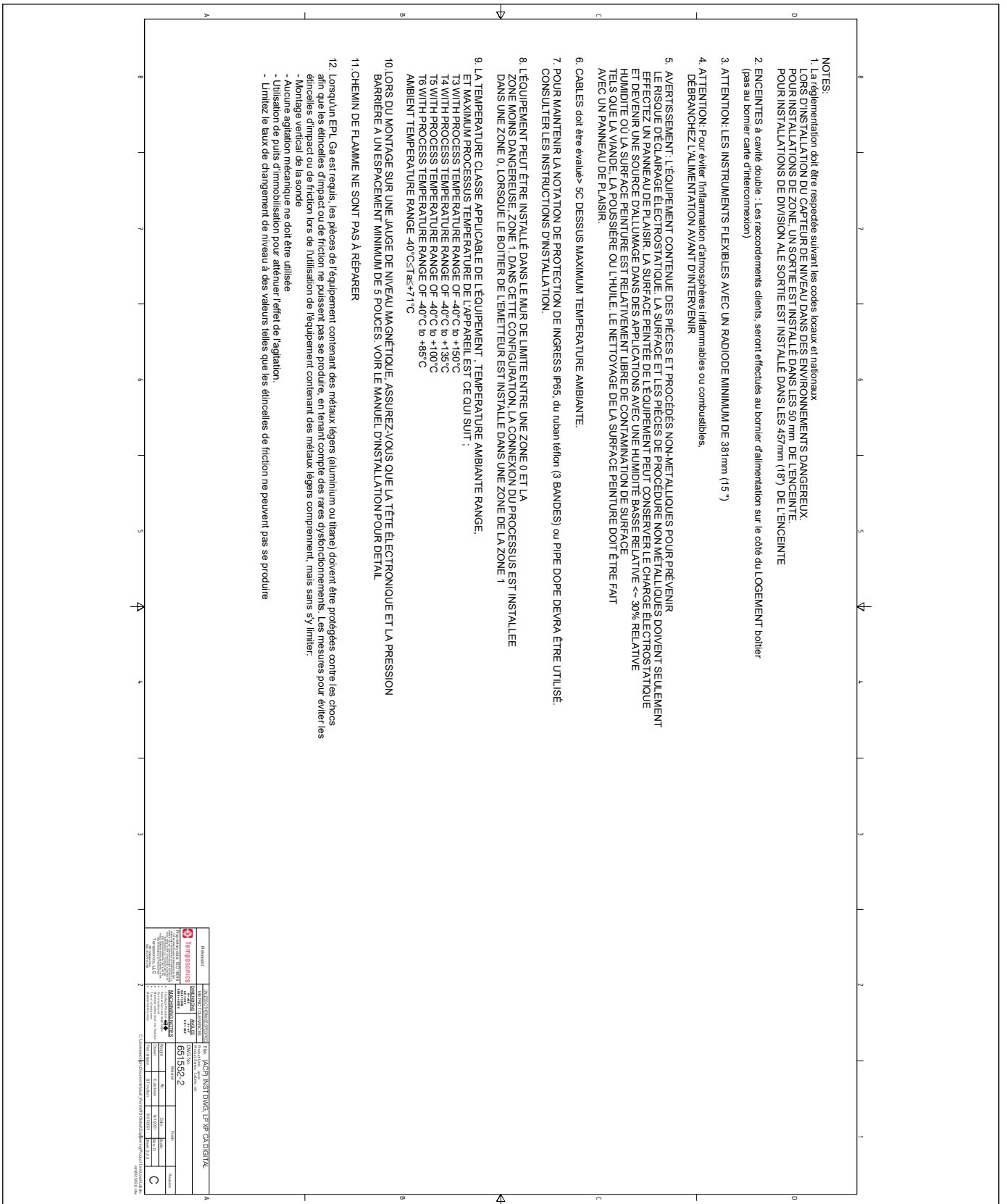

Fig. 46: Explosion proof, FMC Installation Drawing, Modbus and DDA, Page 3

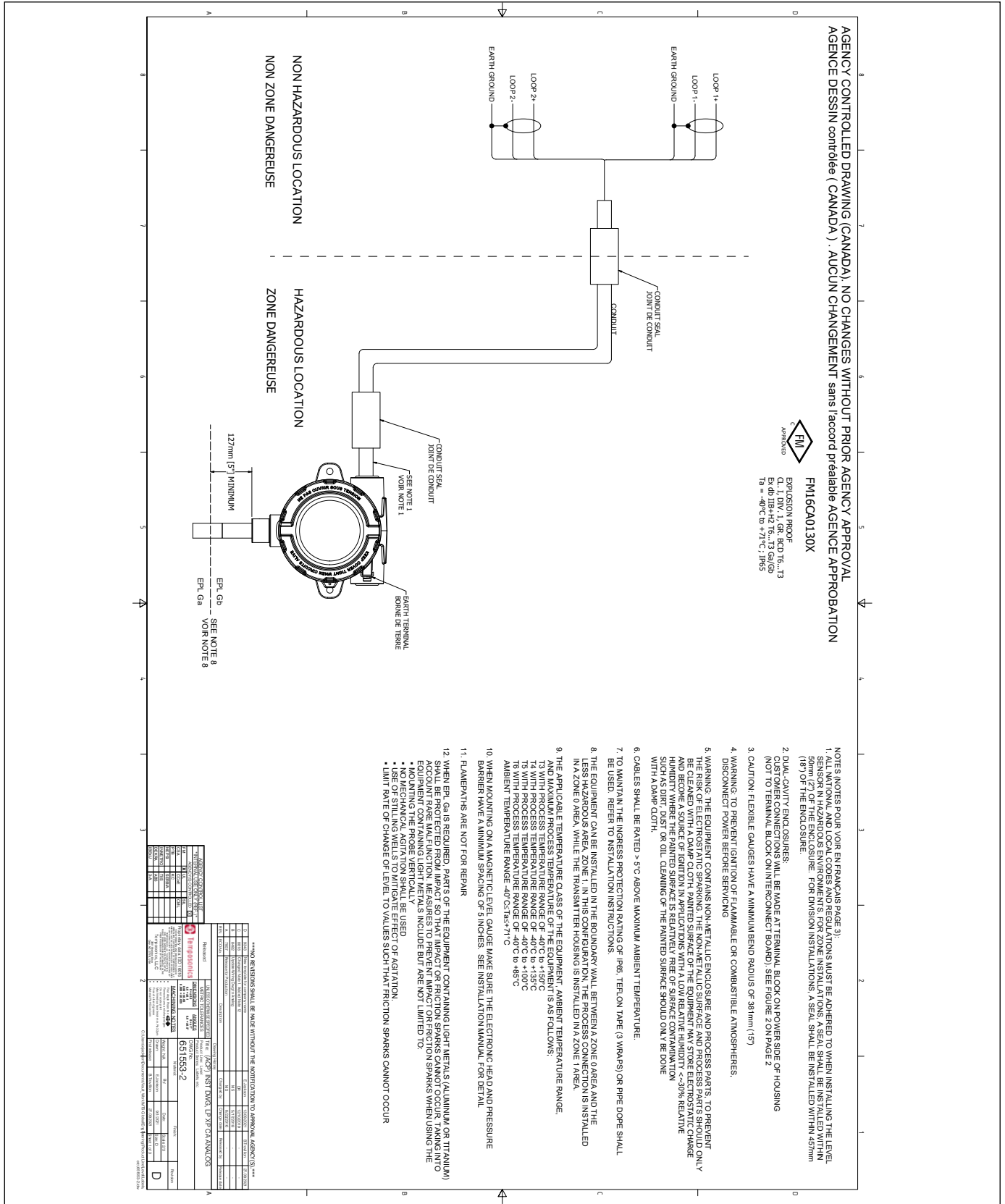

Fig. 47: Explosion proof, FMC Installation Drawing, HART®, Page 1

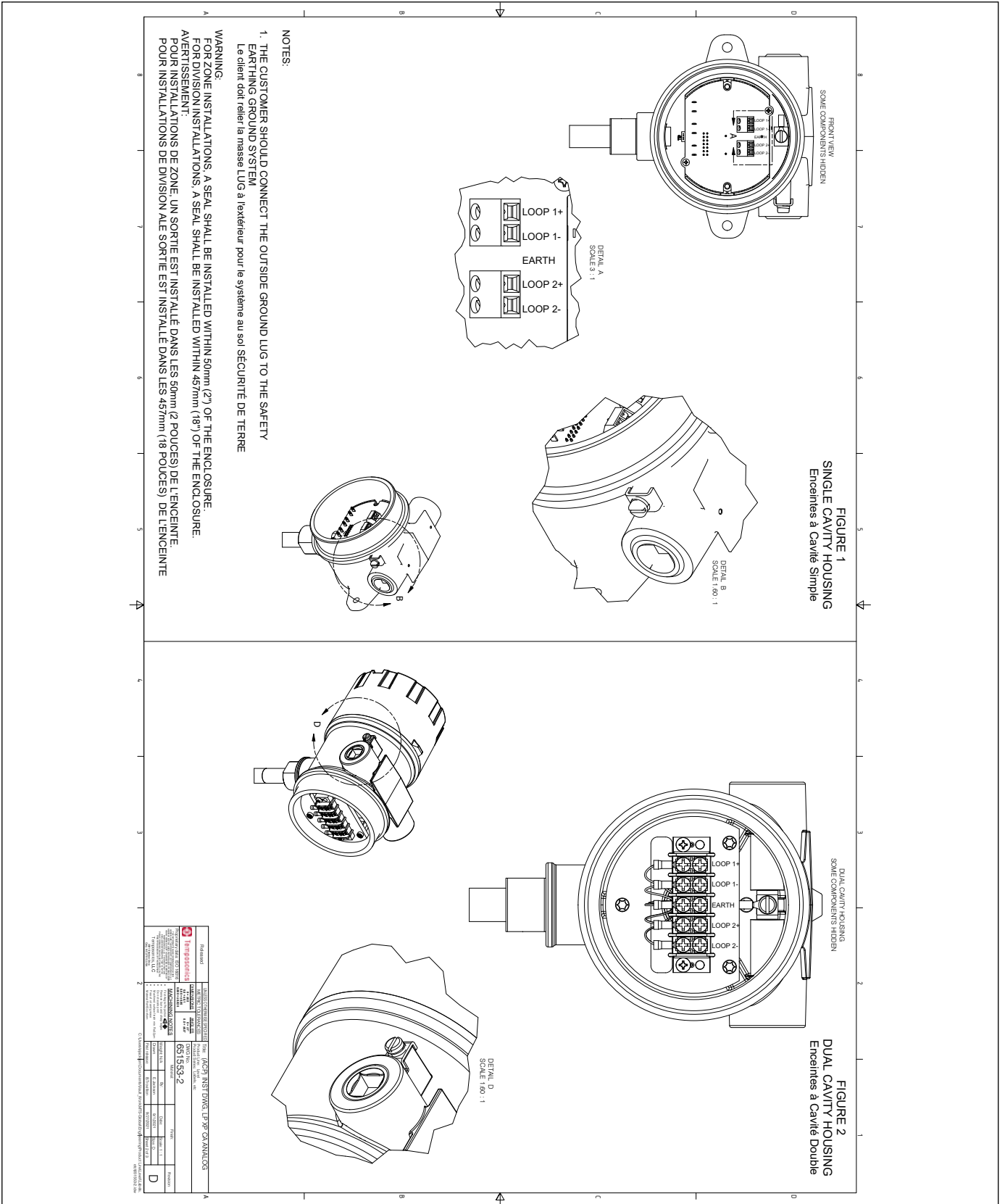

Fig. 48: Explosion proof, FMC Installation Drawing, HART®, Page 2

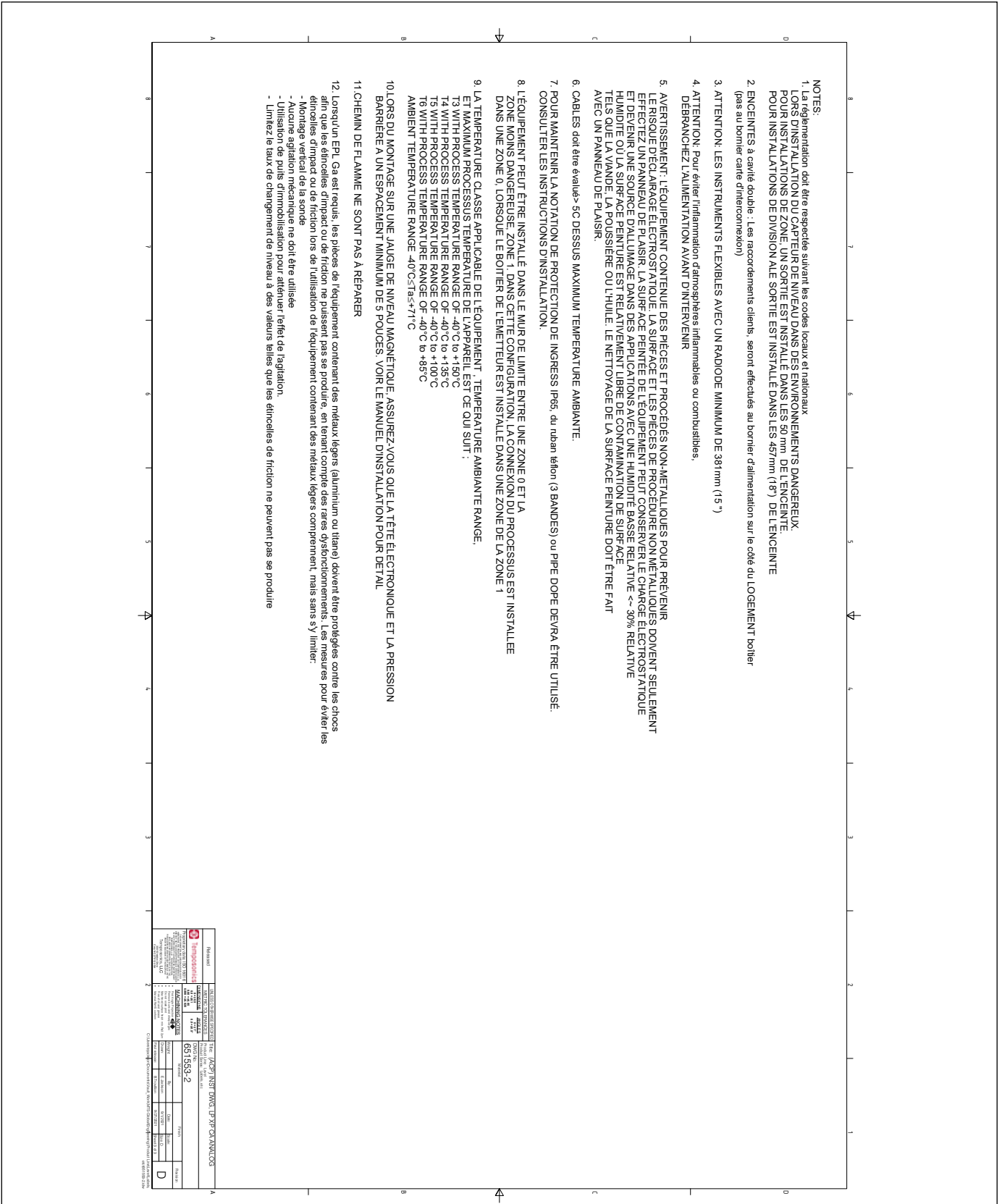

Fig. 49: Explosion proof, FMC Installation Drawing, HART®, Page 3

13.5 ATEX/IECEX/UKCA

13.5.1 ATEX/IECEX/UKCA IS

13.5.1.1 Specific conditions of safe use

- When EPL Ga or Da is required, parts of the equipment containing light metals (Aluminum or Titanium) shall be protected from impact so that impact or friction sparks cannot occur, taking into account rare malfunction. Measures to prevent impact or friction sparks when using the equipment containing light metals include but are not limited to:
 - Mounting the probe vertically
 - No mechanical agitation shall be used
 - Use of stilling wells to mitigate effect of agitation.
 - Limit rate of change of level to values such that friction sparks cannot occur
- The maximum permitted ambient temperature of the Level Plus Digital/Analog Level Transmitter is 71 °C. To avoid the effects of process temperature and other thermal effects care shall be taken to ensure the surrounding ambient and the ambient inside the transmitter housing does not exceed 71°C
- Warning: The equipment contains non-metallic enclosure and process parts. To prevent the risk of electrostatic sparking, the non-metallic surface should only be cleaned with a damp cloth. Painted surface of the equipment may store electrostatic charge and become a source of ignition in applications with a low relative humidity <~30% relative humidity where the painted surface is relatively free of surface contamination such as dirt, dust or oil. Cleaning of the painted surface should only be done with a damp cloth.
- The applicable temperature class, process temperature range and ambient temperature range of the equipment is as follows;
 - T3 with Process Temperature Range of -40°C to 150°C
 - T4 with Process Temperature Range of -40°C to 135°C
 - T5 with Process Temperature Range of -40°C to 100°C
 - T6 with Process Temperature Range of -40°C to 85°C
 - Ambient Temperature Range -40°C < Ta < 71°C

13.5.1.2 Labels

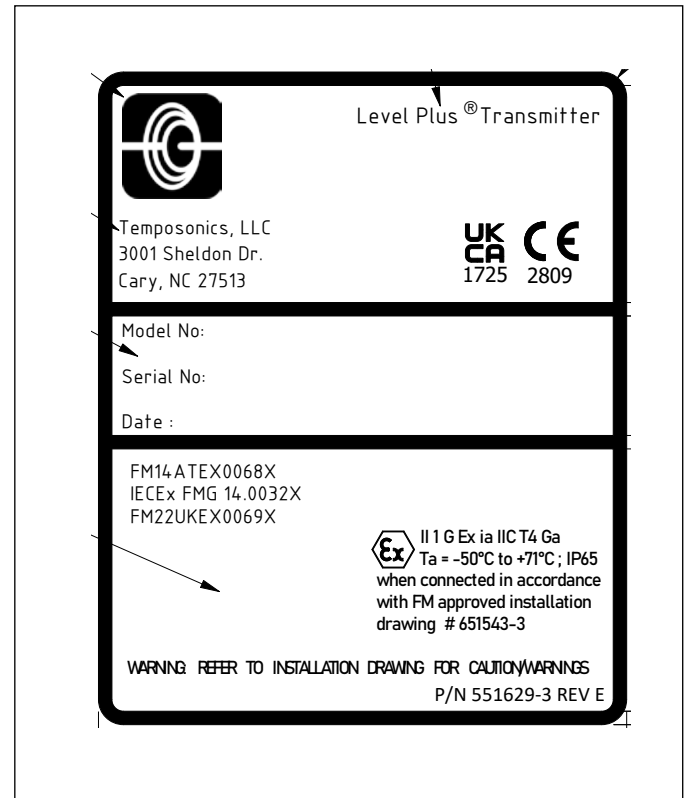

Fig. 50: Intrinsic Safe ATEX, IECEX, and UKCA label, Modbus and DDA, NEMA Housing

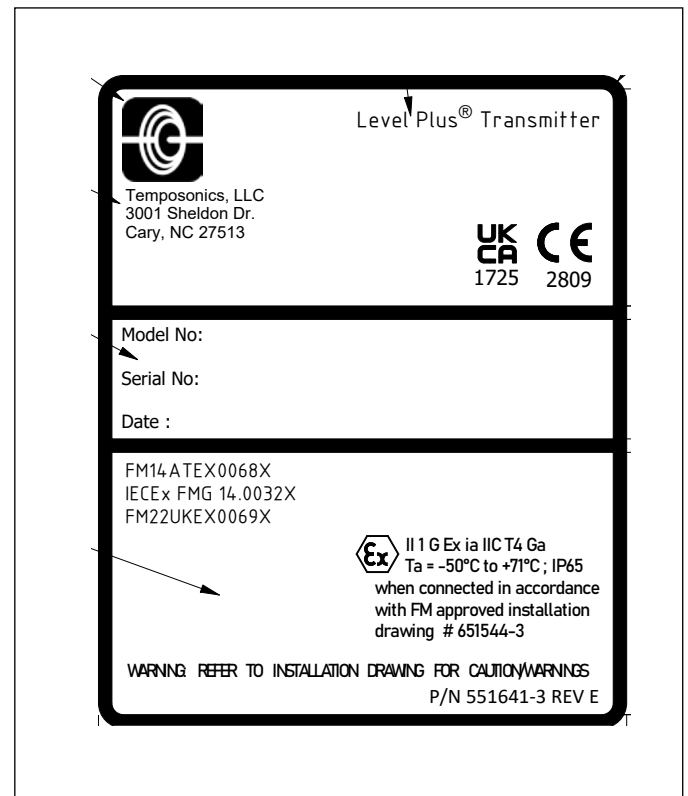

Fig. 51: Intrinsic Safe ATEX, IECEX, and UKCA label, Modbus and DDA, NEMA Housing

Level Plus® CHAMBERED
 Operation Manual

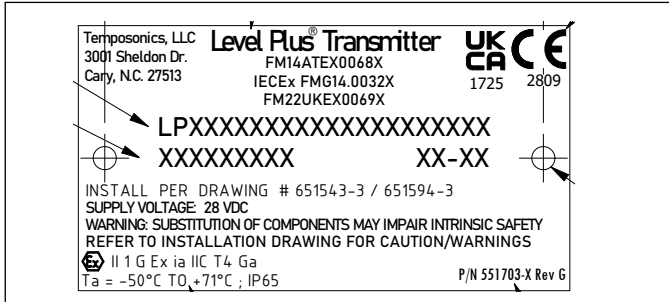

Fig. 52: Intrinsically Safe ATEX, IECEx, and UKCA label, Modbus and DDA, Single and Dual Cavity Housing

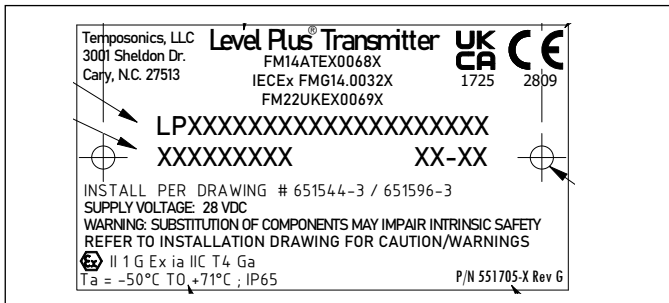

Fig. 53: Intrinsically Safe ATEX, IECEx, and UKCA label, Modbus and DDA, Single and Dual Cavity Housing

13.5.1.3 Installation drawing

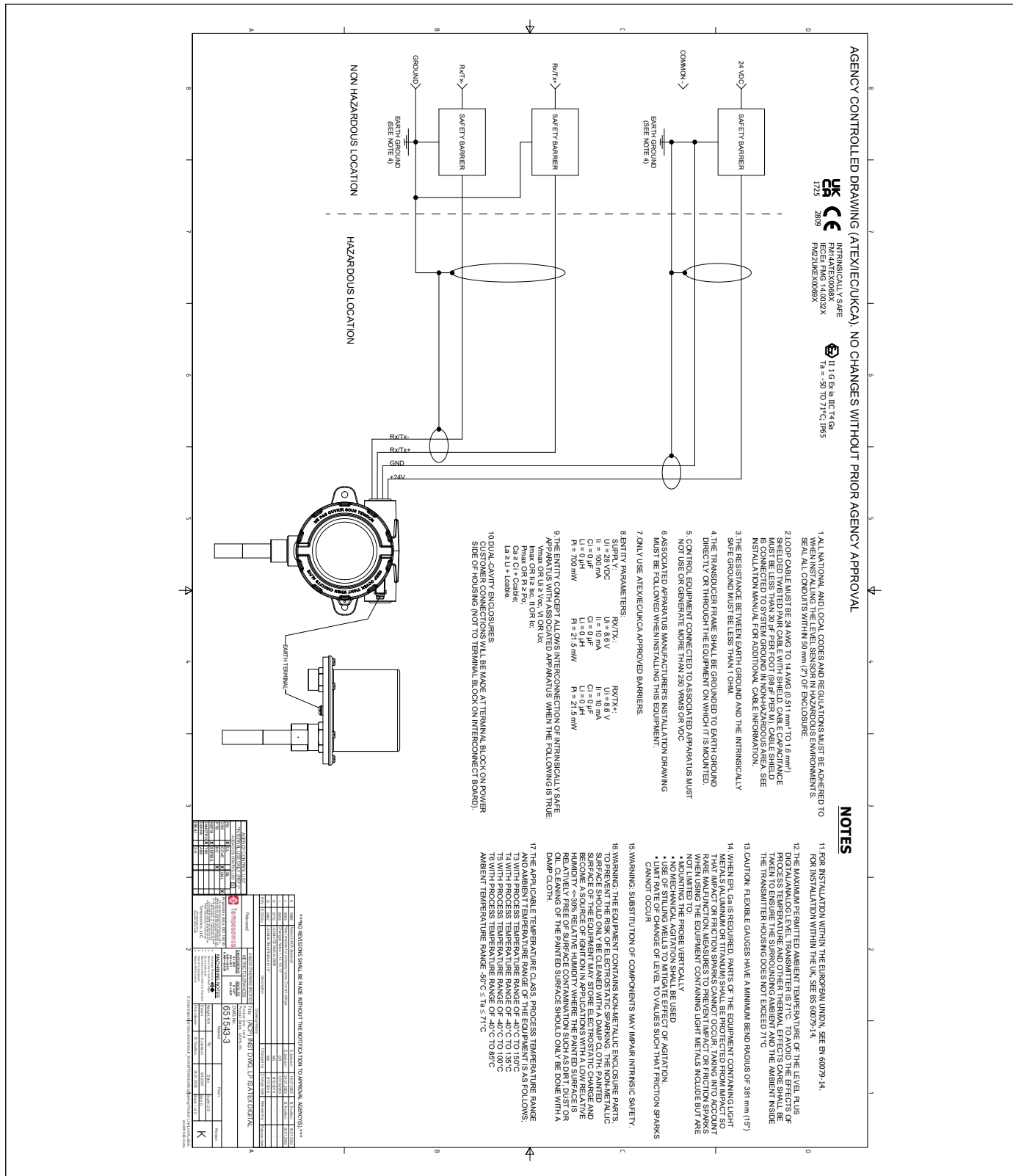

Fig. 54: Intrinsically Safe ATEX, IECEx, and UKCA installation drawing, Modbus and DDA, Page 1

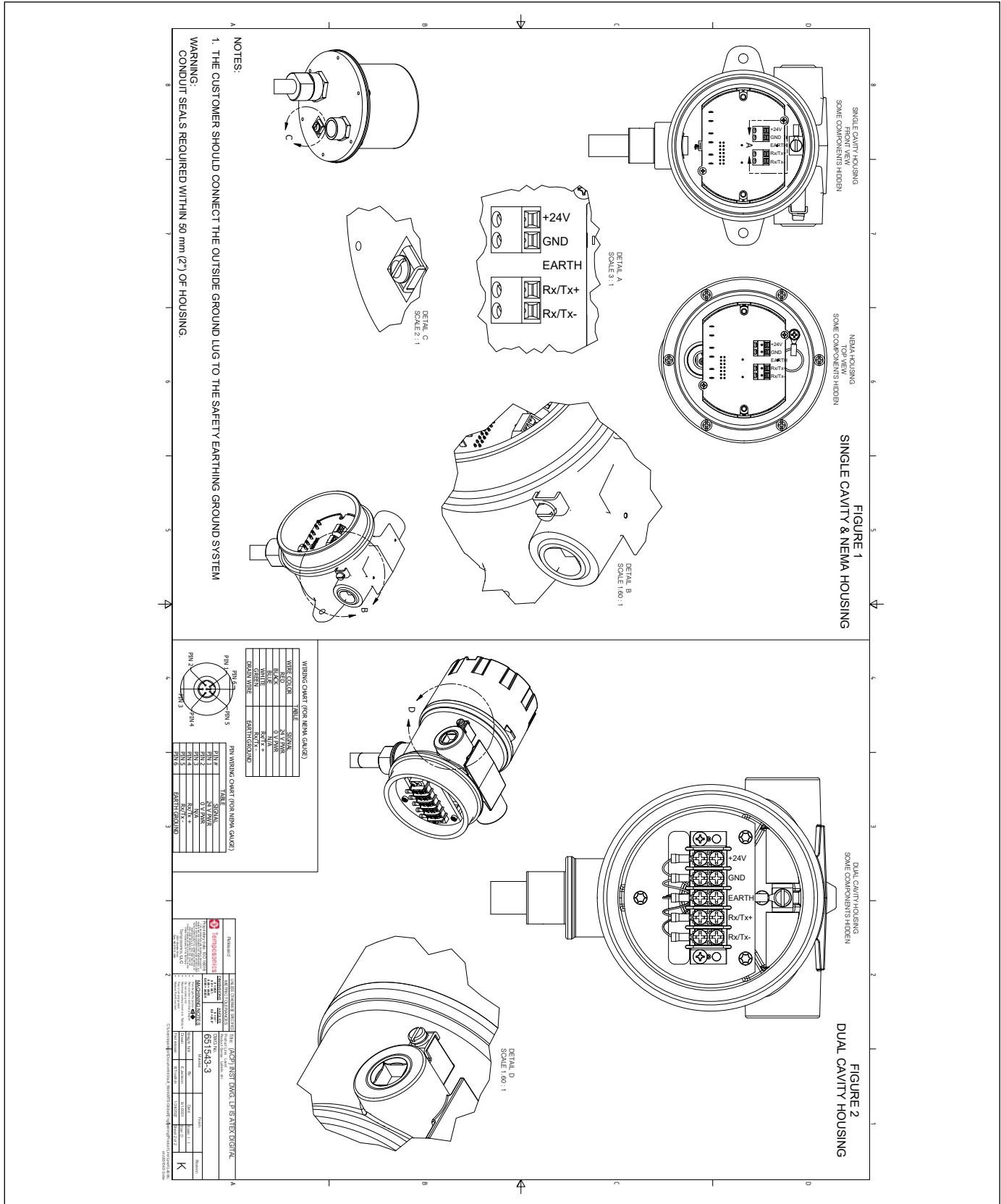

Fig. 55: Intrinsically Safe ATEX, IECEx, and UKCA installation drawing, Modbus and DDA, Page 2

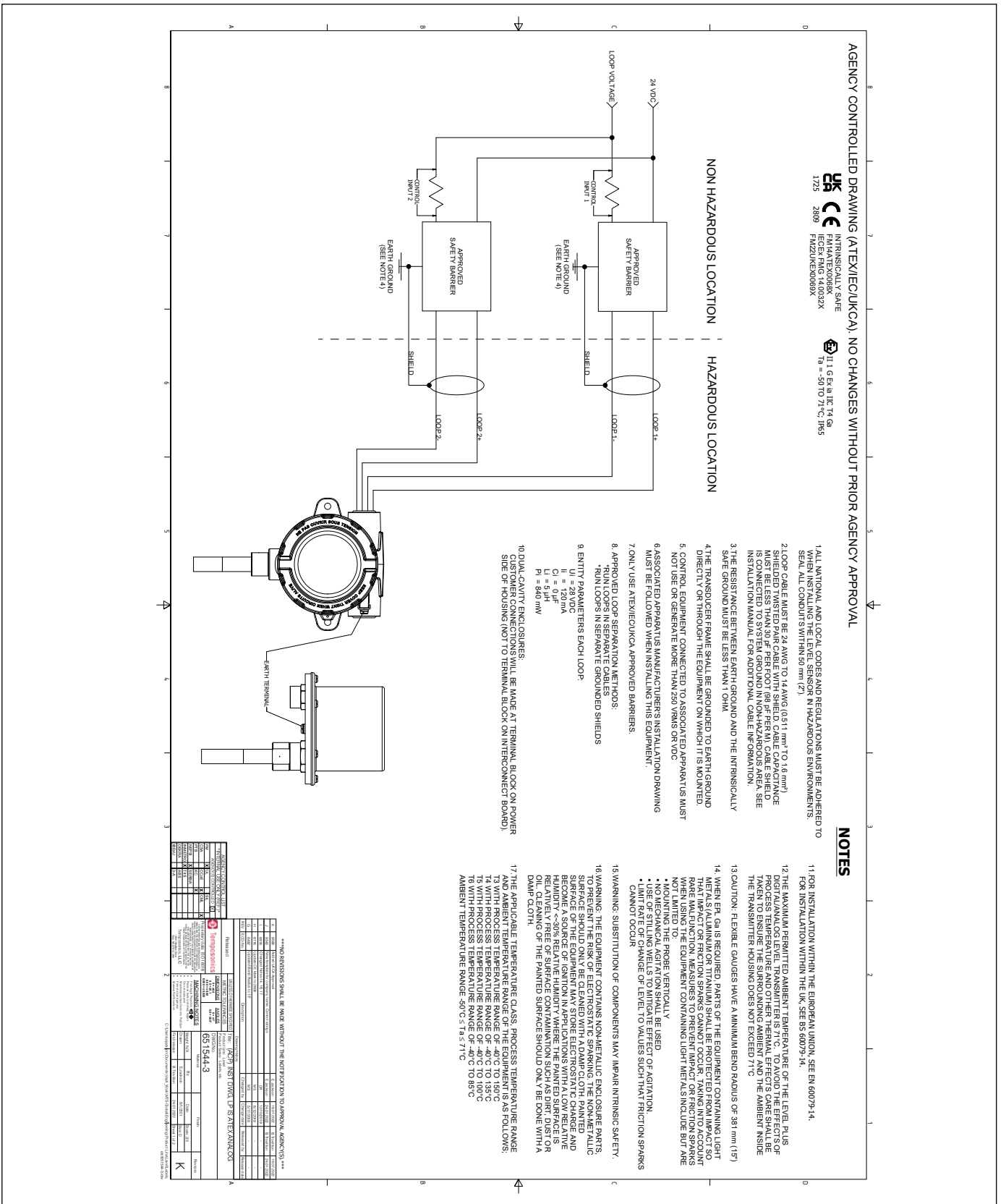

Fig. 56: Intrinsically Safe ATEX, IECEx, and UKCA installation drawing, HART®, Page 1

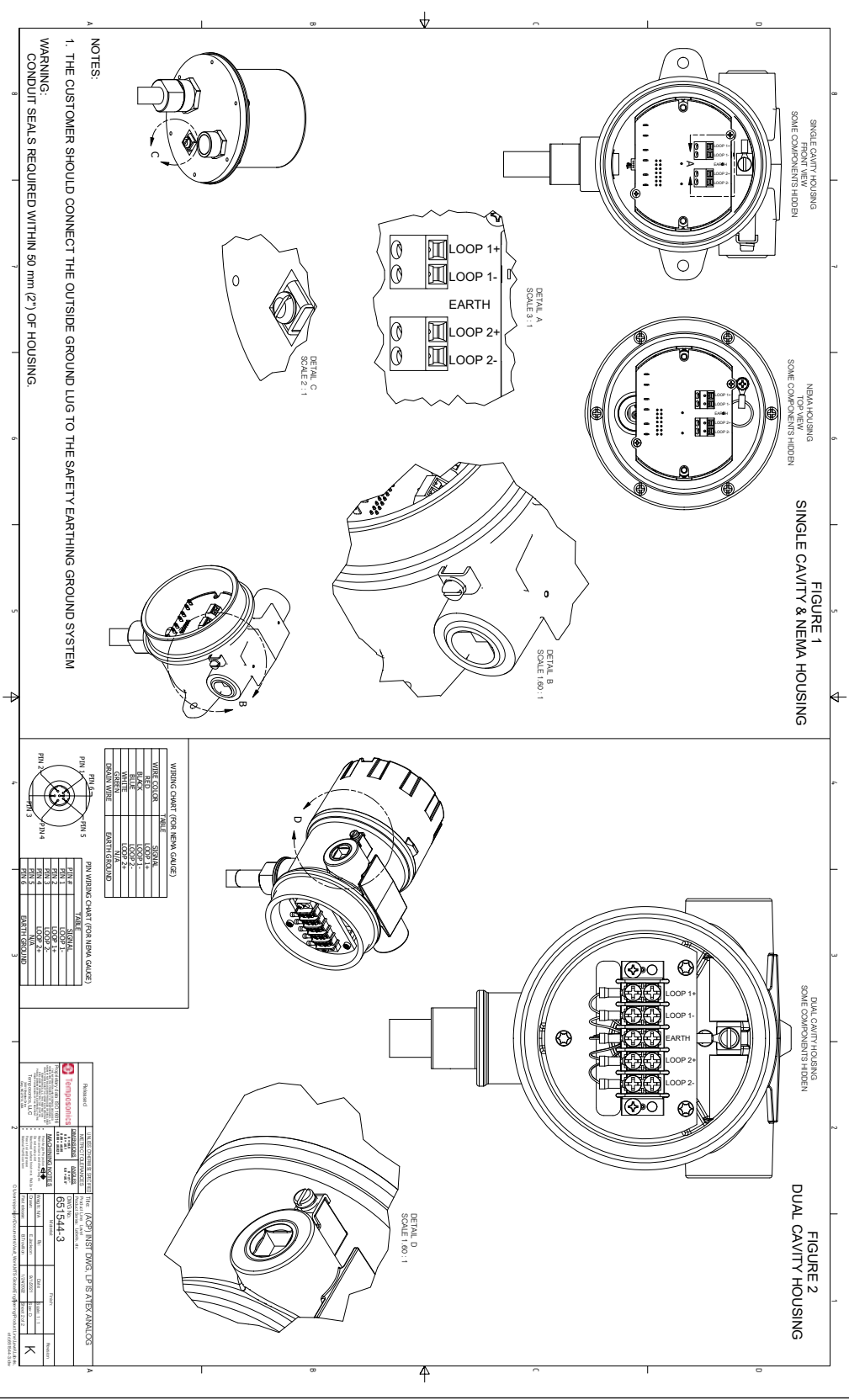

Fig. 57: Intrinsically Safe ATEX, IECEx, and UKCA installation drawing, HART®, Page 2

13.5.2 ATEX/IECEX/UKCA XP

13.5.2.1 Specific Conditions of Safe Use

1. Warning: The equipment contains non-metallic enclosure and process parts. To prevent the risk of electrostatic sparking, the non-metallic surface should only be cleaned with a damp cloth. Painted surface of the equipment may store electrostatic charge and become a source of ignition in applications with a low relative humidity <~30% relative humidity where the painted surface is relatively free of surface contamination such as dirt, dust or oil. Cleaning of the painted surface should only be done with a damp cloth.
2. Cables shall be rated > 5 °C above maximum ambient temperature.
3. To maintain the ingress protection rating of IP65, Teflon tape (3 wraps) or pipe dope shall be used. Refer to Installation Instructions.
4. Equipment can be installed in a boundary wall configuration where the process connection is installed as Category 1G equipment while the transmitter housing is installed as Category 2G equipment. Refer to installation instructions.
5. Flexible gauges have a minimum bend diameter of 381mm (15 inches).
6. Flamepaths not for repair.
7. The applicable temperature class, process temperature range and ambient temperature range of the equipment is as follows;
 - T3 with Process Temperature Range of -40 °C to 150 °C
 - T4 with Process Temperature Range of -40 °C to 135 °C
 - T5 with Process Temperature Range of -40 °C to 100 °C
 - T6 with Process Temperature Range of -40 °C to 85 °C
 - Ambient Temperature Range -40 °C < Ta < 71 °C
8. When mounting on a MLG (magnetic level gauge) make sure the electronic head and pressure barrier have a minimum spacing of 5 inches. See Installation Manual for detail.
9. When EPL Ga or Da is required, parts of the equipment containing light metals (Aluminum or Titanium) shall be protected from impact so that impact or friction sparks cannot occur, taking into account rare malfunction. Measures to prevent impact or friction sparks when using the equipment containing light metals include but are not limited to:
 - Mounting the probe vertically
 - No mechanical agitation shall be used
 - Use of stilling wells to mitigate effect of agitation.
 - Limit rate of change of level to values such that friction sparks cannot occur

13.5.2.2 Labels

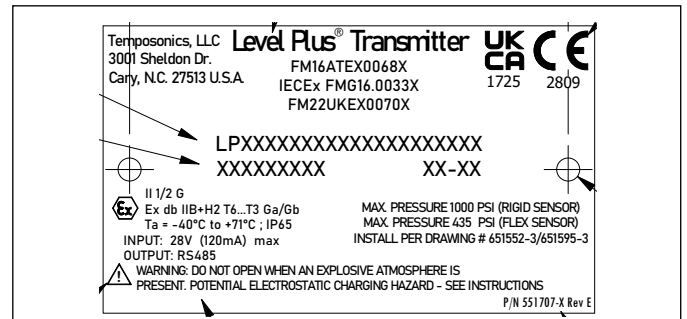

Fig. 58: Flameproof, ATEX/IECEX and UKCA label, Modbus or DDA Housing Option D, E, G, H, or L



Fig. 59: Flameproof, ATEX/IECEX and UKCA label, HART®, Housing Option D, E, G, H, or L

13.5.2.3 Installation drawing

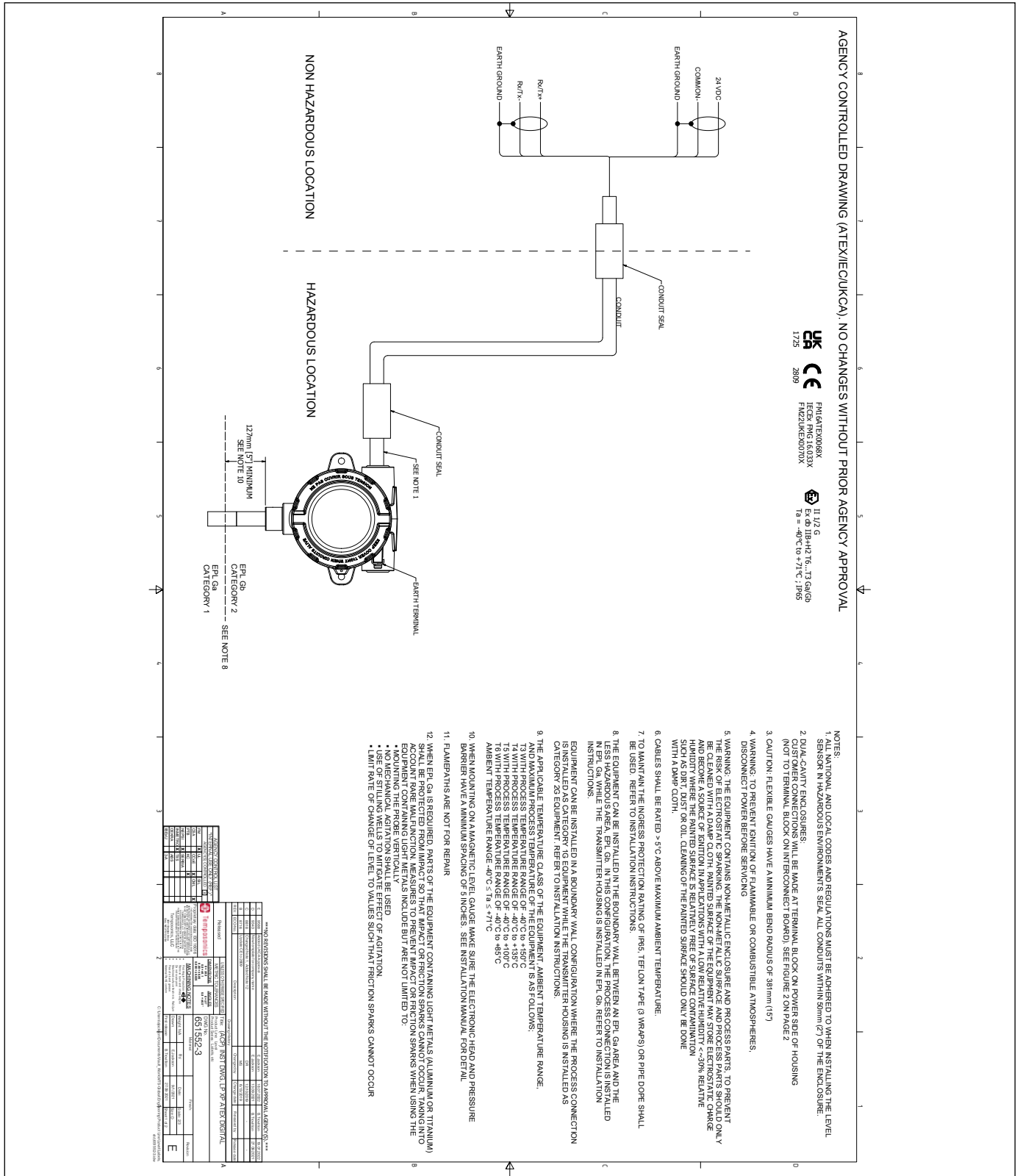

Fig. 60: Flameproof, ATEX, IECEx, and UKCA Installation Drawing, Modbus and DDA, Page 1

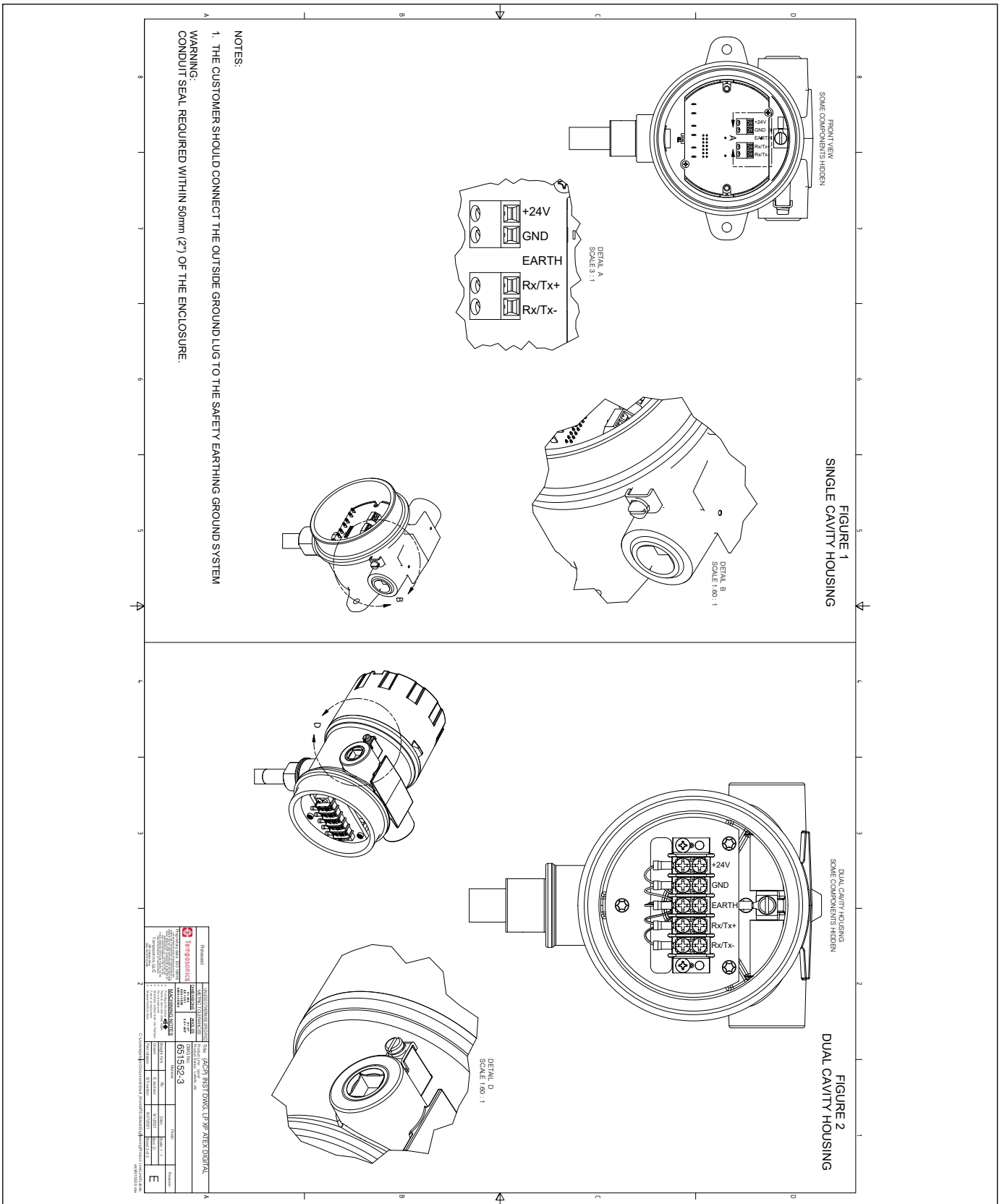

Fig. 61: Flameproof, ATEX, IECEx, and UKCA Installation Drawing, Modbus and DDA

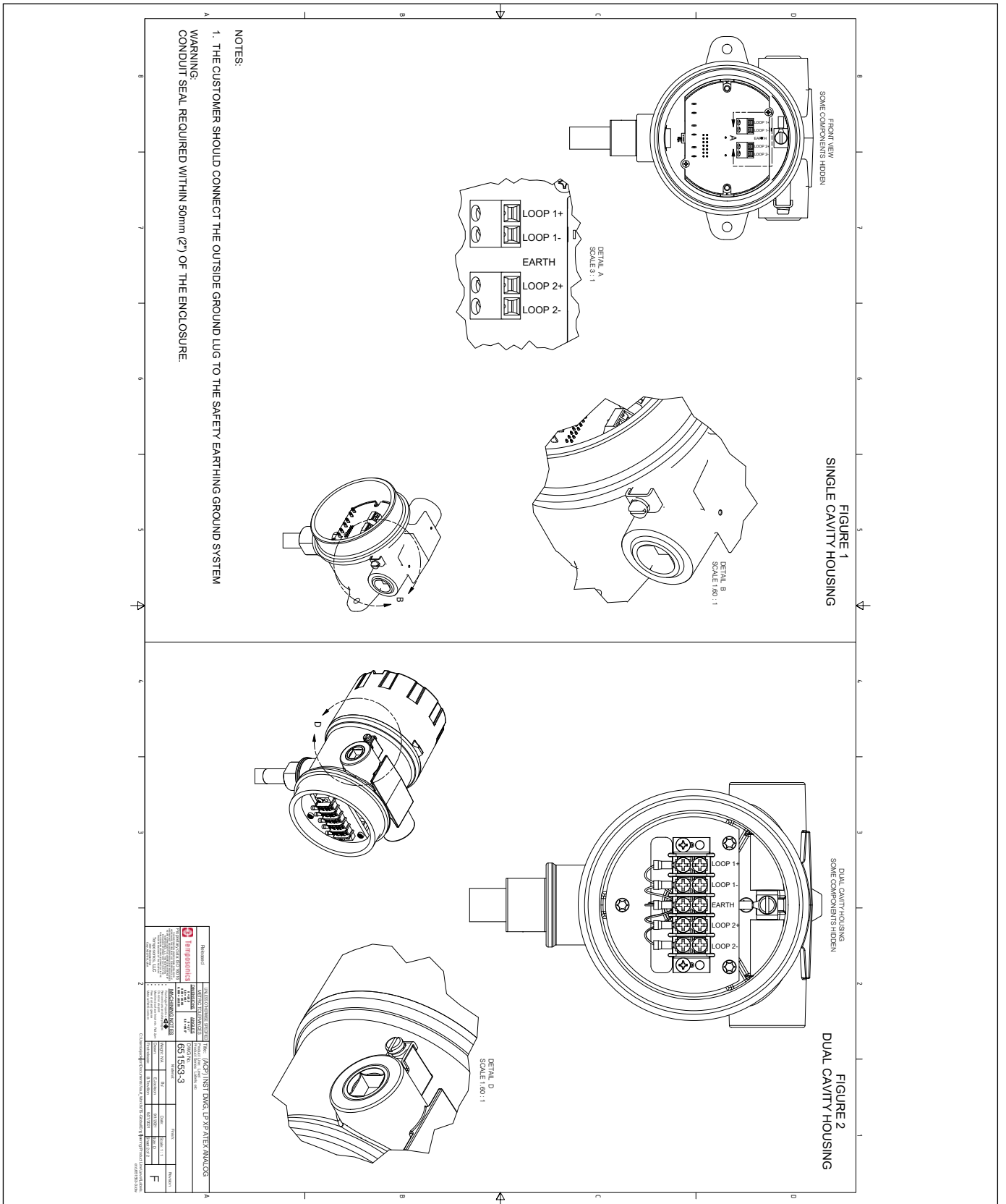

Fig. 63: Flameproof, ATEX, IECEx, and UKCA Installation Drawing, HART®, Page 2

13.5.3 EC Declaration of conformity

EU Declaration of Conformity | EU Konformitätserklärung | Déclaration UE de Conformité

Temposonics LLC, 3001 Sheldon Drive, Cary NC 27513, USA

EU21.501B

declares as manufacturer in sole responsibility that the products
erklärt als Hersteller in alleiniger Verantwortung, dass die Produkte
déclare en qualité de fabricant sous sa seule responsabilité que les produits

Level Plus LPT x_x_x_x_x_x_x_x_x_x_E_I_x_x_x_x_x_x_x_x_x_x (Tank Slayer)

Level Plus LPR x_x_x_x_x_x_x_x_x_x_E_I_x_x_x_x_x_x_x_x_x_x (RefineME)

Level Plus LPS x_x_x_x_x_x_x_x_x_x_E_I_x_x_x_x_x_x_x_x_x_x (SoClean)

Level Plus LPC x_x_x_x_x_x_x_x_x_x_E_I_x_x_x_x_x_x_x_x_x_x (Chambered)

Level Plus LPL x_x_x_x_x_x_x_E_I_x_x_x_x_x_x_x_x_x_x_x_x_x_x_x_x_x_x_x (LevelLimit)

comply with the regulations of the following European Directives:
den Vorschriften folgender europäischer Richtlinien entsprechen:
sont conformes aux prescriptions des directives européennes suivantes :

- | | |
|-------------------|---|
| 2014/34/EU | Equipment and protective systems for use in potentially explosive atmospheres
Geräte und Schutzsysteme zur Verwendung in explosionsgefährdeten Bereichen
Appareils et systèmes de protection à être utilisés en atmosphères explosibles |
| 2014/30/EU | Electromagnetic Compatibility
Elektromagnetische Verträglichkeit
Compatibilité électromagnétique |
| 2011/65/EU | Restriction of the use of hazardous substances in electrical and electronic equipment
Beschränkung der Verwendung gefährlicher Stoffe in Elektro- und Elektronikgeräten
Limitation de l'utilisation de substances dangereuses dans les équipements électriques et électroniques |

Applied harmonized standards:
Angewandte harmonisierte Normen:
Normes harmonisées appliquées :

**EN 60079-0:2018, EN 60079-11:2012, EN 60079-26:2015, EN 60529:1991+A1:2000+A2:2013,
EN 61326-1:2013, EN 61326-2-3:2013, EN IEC 63000:2018**

EU type examination certificate:
EU-Baumusterprüfbescheinigung:
Certificat de l'examen CE :

FM14ATEX0068X

issued by / ausgestellt durch / exposé par :

**FM Approvals Europe Ltd.
Dublin, Ireland, One Georges Quay Plaza, D02 E440**

Notified body for quality assurance control:
Benannte Stelle für Qualitätsüberwachung:
Organisme notifié pour l'assurance qualité :

**FM Approvals Europe Ltd.
Dublin, Ireland, One Georges Quay Plaza, D02 E440**

Ident number / Kennnummer / Numéro d'identification :

2809

Marking/Kennzeichnung / Marquage :

 **II 1 G Ex ia IIC T4 Ga
Ta = -50°C to +71°C**

Cary, 2022-01-26



Uwe Viola
Industrial Engineering Manager
EX Authorized Representative



Temposonics LLC - 3001 Sheldon Drive - Cary, NC 27513 - USA



EU Declaration of Conformity | EU Konformitätserklärung | Déclaration UE de Conformité

Temposonics LLC, 3001 Sheldon Drive, Cary NC 27513, USA

EU21.502A

declares as manufacturer in sole responsibility that the products
erklärt als Hersteller in alleiniger Verantwortung, dass die Produkte
déclare en qualité de fabricant sous sa seule responsabilité que les produits

Level Plus LPT x_x_x_x_x_x_x_x_x_x_E_F_x_x_x_x_x_x_x_x_x_x (Tank Slayer)

Level Plus LPR x_x_x_x_x_x_x_x_x_x_E_F_x_x_x_x_x_x_x_x_x_x (RefineME)

Level Plus LPS x_x_x_x_x_x_x_x_x_x_E_F_x_x_x_x_x_x_x_x_x_x (SoClean)

Level Plus LPC x_x_x_x_x_x_x_x_x_x_E_F_x_x_x_x_x_x_x_x_x_x (Chambered)

Level Plus LPL x_x_x_x_x_x_x_x_x_x_E_F_x_x_x_x_x_x_x_x_x_x_x_x_x_x_x_x (LevelLimit)

comply with the regulations of the following European Directives:
den Vorschriften folgender europäischer Richtlinien entsprechen:
sont conformes aux prescriptions des directives européennes suivantes :

- | | |
|-------------------|---|
| 2014/34/EU | Equipment and protective systems for use in potentially explosive atmospheres
Geräte und Schutzsysteme zur Verwendung in explosionsgefährdeten Bereichen
Appareils et systèmes de protection à être utilisés en atmosphères explosibles |
| 2014/30/EU | Electromagnetic Compatibility
Elektromagnetische Verträglichkeit
Compatibilité électromagnétique |
| 2011/65/EU | Restriction of the use of hazardous substances in electrical and electronic equipment
Beschränkung der Verwendung gefährlicher Stoffe in Elektro- und Elektronikgeräten
Limitation de l'utilisation de substances dangereuses dans les équipements électriques et électroniques |

Applied harmonized standards:
Angewandte harmonisierte Normen:
Normes harmonisées appliquées :

**EN 60079-0:2018, EN 60079-1:2014, EN 60079-26:2015, EN 60529:1991+A1:2000+A2:2013,
EN 61326-1:2013, EN 61326-2-3:2013, EN IEC 63000:2018**

EU type examination certificate:

EU-Baumusterprüfbescheinigung:

Certificat de l'examen CE :

issued by / ausgestellt durch / exposé par :

FM16ATEX0068X

FM Approvals Europe Ltd.

Dublin, Ireland, One Georges Quay Plaza, D02 E440

Notified body for quality assurance control:

Benannte Stelle für Qualitätsüberwachung:

Organisme notifié pour l'assurance qualité :

FM Approvals Europe Ltd.

Dublin, Ireland, One Georges Quay Plaza, D02 E440

Ident number / Kennnummer / Numéro d'identification :

2809

Marking/Kennzeichnung / Marquage :

**Ex II 1/2 G Ex db IIB+H₂ T6...T3 Ga/Gb
Ta = -40°C to +71°C**

Cary, 2021-11-30

Uwe Viola
Industrial Engineering Manager
EX Authorized Representative



UKCA Declaration of Conformity

UC22.001A

Temposonics LLC, 3001 Sheldon Drive, Cary NC 27513, USA

declares as manufacturer in sole responsibility that the products

Level Plus LPT x_x_x_x_x_x_x_x_x_x_U_F_x_x_x_x_x_x_x_x_x_x (Tank SLAYER®)

Level Plus LPR x_x_x_x_x_x_x_x_x_x_U_F_x_x_x_x_x_x_x_x_x_x (RefineME®)

Level Plus LPS x_x_x_x_x_x_x_x_x_x_U_F_x_x_x_x_x_x_x_x_x_x (SoClean®)

Level Plus LPC x_x_x_x_x_x_x_x_x_x_U_F_x_x_x_x_x_x_x_x_x_x (CHAMBERED)

Level Plus LPL x_x_x_x_x_x_x_x_x_x_U_F_x_x_x_x_x_x_x_x_x_x (LevelLimit)

comply with the regulations of the following British Standards Directives:

Equipment and Protective Systems Intended for Use in Potentially Explosive Atmospheres Regulation 2016

Electromagnetic Compatibility Regulations 2016

The Restriction of the Use of Certain Hazardous Substances in Electrical and Electronic Equipment Regulations 2012

Applied harmonized standards:

BS 60079-0:2018, BS 60079-1:2014, BS 60079-26 :2015, BS 60529:1991+A1:2000+A2:2013,
BS 61326-1:2013, BS 61326-2-3:2013, BS 50581:2012

UKCA type examination certificate:

FM22UKEX0070X

Notified body for quality assurance control:

FM Approvals Ltd.
Windsor, Berkshire, United Kingdom

Ident number:

1725

Marking:

Ex db IIB+H2 T6...T3 Ga/Gb
Ta = -40°C to +71°C; IP65

Cary, 2022-05-02

Temposonics LLC, 3001 Sheldon Drive, Cary NC 27513, USA

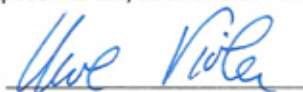

Uwe Viola
Industrial Engineering Manager
EX Authorized Representative



UKCA Declaration of Conformity

UC22.002A

Temposonics LLC, 3001 Sheldon Drive, Cary NC 27513, USA

declares as manufacturer in sole responsibility that the products

Level Plus LPT x_x_x_x_x_x_x_x_x_x_U_F_x_x_x_x_x_x_x_x_x_x (Tank SLAYER®)

Level Plus LPR x_x_x_x_x_x_x_x_x_x_U_F_x_x_x_x_x_x_x_x_x_x (RefineME®)

Level Plus LPS x_x_x_x_x_x_x_x_x_x_U_F_x_x_x_x_x_x_x_x_x_x (SoClean®)

Level Plus LPC x_x_x_x_x_x_x_x_x_x_U_F_x_x_x_x_x_x_x_x_x_x (CHAMBERED)

Level Plus LPL x_x_x_x_x_x_x_x_x_x_U_F_x_x_x_x_x_x_x_x_x_x (LevelLimit)

comply with the regulations of the following British Standards Directives:

Equipment and Protective Systems Intended for Use in Potentially Explosive Atmospheres Regulation 2016

Electromagnetic Compatibility Regulations 2016

The Restriction of the Use of Certain Hazardous Substances in Electrical and Electronic Equipment Regulations 2012

Applied harmonized standards:

BS 60079-0:2018, BS 60079-11:2012, BS 60529:1991+A1:2000+A2:2013,
BS 61326-1:2013, BS 61326-2-3:2013, BS 50581:2012

UKCA type examination certificate:

FM22UKEX0069X

Notified body for quality assurance control:

FM Approvals Ltd.
Windsor, Berkshire, United Kingdom

Ident number:

1725

Marking:

Ex ia IIC T4 Ga
Ta = -50°C to +71°C; IP65

Cary, 2022-05-02

Temposonics LLC, 3001 Sheldon Drive, Cary NC 27513, USA

Uwe Viola

Industrial Engineering Manager
EX Authorized Representative



UNITED STATES
Temposonics, LLC
Americas & APAC Region
3001 Sheldon Drive
Cary, N.C. 27513
Phone: +1 919 677-0100
E-mail: info.us@temposonics.com

GERMANY
Temposonics
GmbH & Co. KG
EMEA Region & India
Auf dem Schüffel 9
58513 Lüdenscheid
Phone: +49 2351 9587-0
E-mail: info.de@temposonics.com

ITALY
Branch Office
Phone: +39 030 988 3819
E-mail: info.it@temposonics.com

FRANCE
Branch Office
Phone: +33 6 14 060 728
E-mail: info.fr@temposonics.com

UK
Branch Office
Phone: +44 79 21 83 05 86
E-mail: info.uk@temposonics.com

SCANDINAVIA
Branch Office
Phone: +46 70 29 91 281
E-mail: info.sca@temposonics.com

CHINA
Branch Office
Phone: +86 21 2415 1000 / 2415 1001
E-mail: info.cn@temposonics.com

JAPAN
Branch Office
Phone: +81 3 6416 1063
E-mail: info.jp@temposonics.com

Document Part Number:
551696 Revision J (EN) 08/2022



temposonics.com