

## Data Sheet

### **R-Series V RD5 Analog** Magnetostrictive Linear Position Sensors

- Space-saving installation due to detached sensor electronics housing
- Distance between sensor rod and sensor electronics up to 20 m (65.6 ft.)
- Field adjustments and diagnostics using the TempoLink® smart assistant



**V**  
THE NEW GENERATION

## MEASURING TECHNOLOGY

The absolute, linear position sensors provided by Temposonics rely on the company's proprietary magnetostrictive technology, which can determine position with a high level of precision and robustness. Each Temposonics® position sensor consists of a ferromagnetic waveguide, a position magnet, a strain pulse converter and supporting electronics. The magnet, connected to the object in motion in the application, generates a magnetic field at its location on the waveguide. A short current pulse is applied to the waveguide. This creates a momentary radial magnetic field and torsional strain on the waveguide. The momentary interaction of the magnetic fields releases a torsional strain pulse that propagates the length of the waveguide. When the ultrasonic wave reaches the beginning of the waveguide it is converted into an electrical signal. Since the speed of the ultrasonic wave in the waveguide is precisely known, the time required to receive the return signal can be converted into a linear position measurement with both high accuracy and repeatability.

## R-SERIES V RD5 Analog

The Temposonics® R-Series V brings very powerful sensor performance to meet the many demands of your application. The sensor RD5 is the version of the R-Series V with a detached sensor electronics. The main advantages of the version RD5 are:

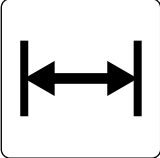
- 

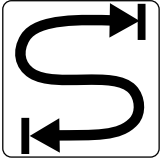
**Space-saving installation**  
The detached sensor electronics allow space-saving installation of the compact measuring rod.
- 

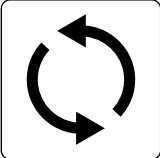
**Great distance**  
The sensor electronics can be mounted up to 20 m (65.6 ft.) away from the sensor rod. This offers more mounting locations for the remote electronics for easier installation, serviceability, or increased protection.
- 

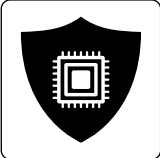
**Swappable sensor electronics**  
The sensor electronics can be ordered separately and can be connected to the previously installed RD5 sensor rod without further adaptation. This simplifies service repairs and saves costs.
- 

**Protection of the sensor electronics**  
By separating the robust sensor rod from the complex evaluation electronics improved protection against process influences can be realized.

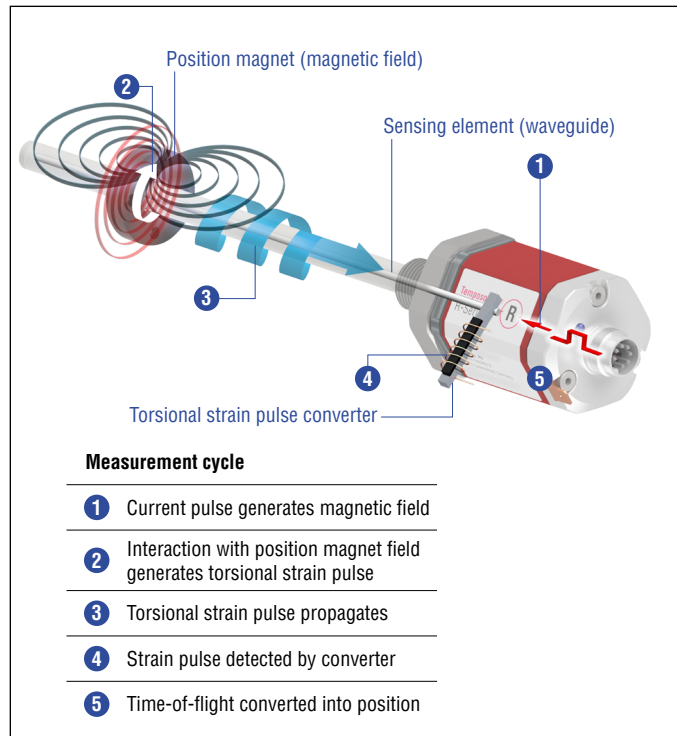



Fig. 1: Time-of-flight based magnetostrictive position sensing principle

In addition the R-Series V Analog scores with the following features:

- 

**2 positions simultaneously**  
The R-Series V Analog can detect and report the position of up to 2 magnets simultaneously.
- 

**R-Series V Analog**  
With the R-Series V Analog you can configure the Analog output (current/voltage) that it fits best for your application and also adjust it on site with the smart assistant.

**All settings under control with the smart assistant for the R-Series V**  
The TempoLink® smart assistant supports you in setup and diagnostics of the R-Series V.

For more information of the assistant please see the data sheet:

- TempoLink® smart assistant  
(Document part number: [552070](#))



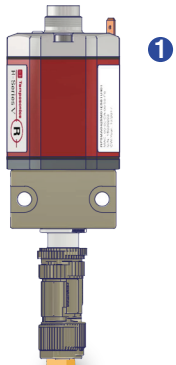

## RD5: COMPLETE SENSOR OR SEPARATE COMPONENTS – IT'S UP TO YOU

The RD5 sensor consists of 2 main components:

- 1 Sensor electronics assembly with mounting block and mating connector
- 2 Sensor rod assembly with cable and connector

The RD5 sensor is the latest version in the RD model line. These sensor models are unique in that their sensor rod is detached from the main electronics components and connected only by a joining cable.

The RD5 sensor is normally ordered as a **complete kit (RD5-K)**. Also, the **sensor rod assembly (RD5-R)** and the **sensor electronics assembly (RD5-E)** can each be ordered separately. This offers added flexibility for ordering just the replacement components needed or for keeping spare components on site for your more critical applications.

## RD5 VERSATILITY FOR SOLVING CHALLENGING APPLICATIONS

The RD5 sensor from Temposonics® is characterized by its remote electronics. This allows you to move the sensor electronics away from the sensor rod for protection from harsh environments or when the installation space at the measuring point is too small to fit a RH5 rod version.

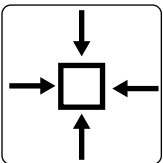

### Configure the sensor you need to fit your confined space applications

RD5 offers new options for confined installation spaces like a small footprint connector and a compact mounting block.

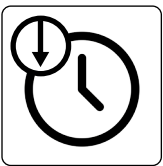

### Reduce or eliminate your machine down time

RD5 offers you easy ordering of spare or replacement components if sensor damage does occur.

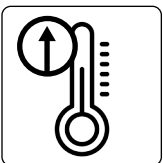

### Use at high temperature applications

The sensor rod assembly of RD5 is rated up to 120 °C (248 °F) for stroke lengths up to 2540 mm (100 in.) and up to 105 °C (221 °F) for longer stroke lengths.

2



## THE RD5 OPTIONS – TO BEST FIT YOUR APPLICATION

### Sensor rod flange options

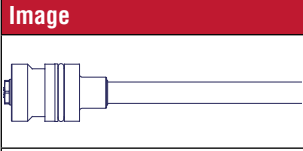
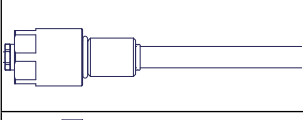
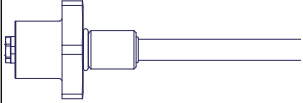
Image	Type	Advantage
	»S«	• Pressure fit for embedding in cylinder
	»M/T«	• Small threaded flange for confined space
	»C/D«	• Large surface hex flange

### Sensor rod cable options

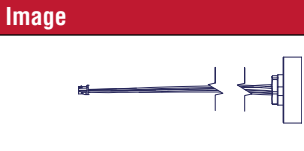
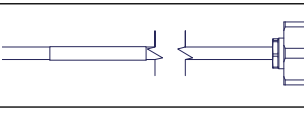
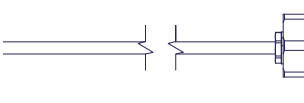
Image	Type	Advantage
	»W«	• Single wires allows small bend radius • For short distances up to 50 cm
	»K«	• PUR cable with min. bend radius of 24 mm • For distances up to 1.15 m
	»J«	• FEP cable with min. bend radius of 57 mm • For great distances up to 20 m

### Sensor rod connectors

(for connecting the sensor rod to the sensor electronics)

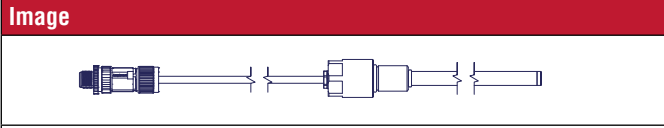
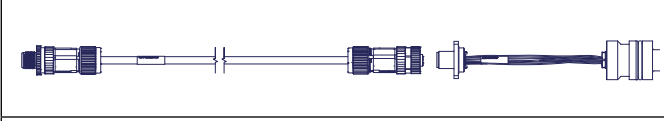
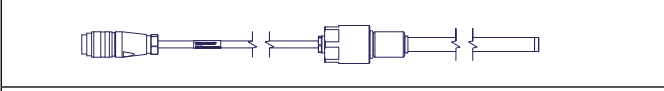
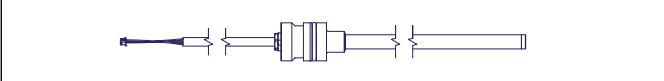
Image	Type	Advantage
	»G«	• Compact inline M12 connector • Suitable for cable type »J« and »K« • For side connection
	»W«	• Small footprint panel mount M12 connector • Suitable for cable type »W« • Requires joining cable RD5-C • For side connection
	»S«	• Standard inline M16 connector • Suitable for cable type »J« and »K« • For side connection
	»E«	• Compact inline flat connector • Suitable for cable type »J«, »K« and »W« • For bottom connection

### Sensor electronics mounting blocks with mating connectors

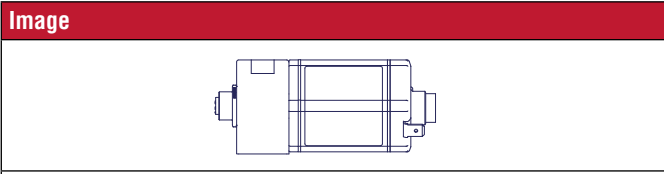
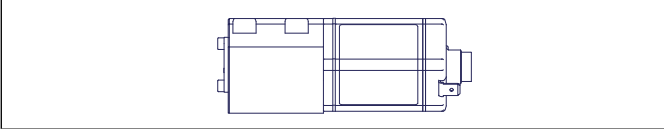
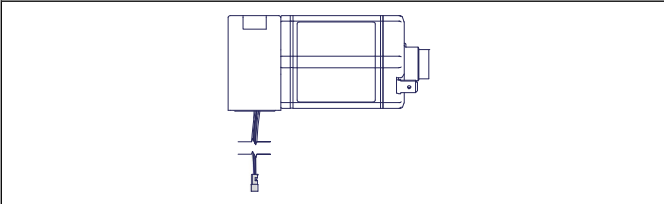
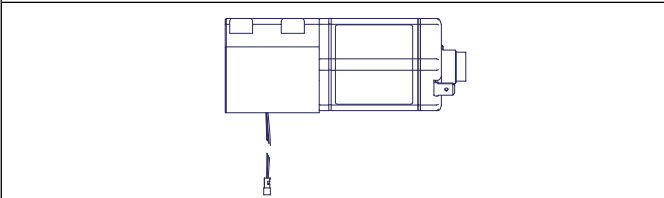
Image	Type	Advantage
	»G«	• Compact mounting block with side M12 mating connector • For sensor rod connector type »G« or joining cable RD5-C • For reduced mounting space
	»S«	• Classic mounting block with side M16 mating connector • For sensor rod connector type »S«
	»E«	• Compact mounting block with bottom connection and flat mating connector • For sensor rod connector type »E« • For reduced mounting space
	»B«	• Classic mounting block with bottom connection and flat mating connector • For sensor rod connector type »E«

## TECHNICAL DATA

Output							
Analog	Voltage: 0...10/10...0/-10...+10/+10...-10 VDC (min. controller load > 5 kΩ) Current: 4(0)...20/20...4(0) mA (min./max. load 0/500 Ω)						
Measured output variables	Position for one or two position magnets Position + speed (without direction) or velocity (with direction) for one position magnet Position for one position magnet + temperature inside the sensor electronics housing						
Measurement parameters							
Position measurement							
Null/Span adjustment	100 % of electrical stroke						
Resolution	16 bit (internal resolution 0.1 μm)						
Update time	Stroke length	≤ 200 mm	≤ 350 mm	≤ 1200 mm	≤ 2400 mm	≤ 4800 mm	≤ 5080 mm
	Update time	0.25 ms	0.333 ms	0.5 ms	1.0 ms	2.0 ms	2.2 ms
Linearity deviation <sup>1,2</sup>	Stroke length	≤ 500 mm	> 500 mm				
	Linearity deviation	≤ ±50 μm	< ±0.01 % F.S.				
Repeatability	< ±0.001 % F.S. (minimum ±1 μm)						
Hysteresis	< 4 μm typical						
Temperature coefficient	< 30 ppm/K typical						
Velocity measurement							
Range	0.01...10 m/s or 1...400 in./s						
Deviation	≤ 0.05 %						
Resolution	16 bit (minimum 0.01 mm/s)						
Operating conditions							
Operating temperature	Sensor electronics housing: -40...+85 °C (-40...+185 °F) Sensor rod with »J« type cable: -40...+120 °C (-40...+248 °F) (for stroke lengths up to 2540 mm (100 in.) and up to 105 °C (221 °F) for longer stroke lengths) Sensor rod with »K« type cable: -40...+80 °C (-40...+176 °F) Sensor rod with »W« type single wires: -40...+85 °C (-40...+185 °F)						
Humidity	90% relative humidity, no condensation						
Ingress protection	Sensor electronics housing: IP67 (with correctly mounted housing and connectors) Sensor rod with »J« or »K« type cable: IP67/IP69K Connector »G« or »S« type: IP67 (correctly mated), Connector »E« type: IP30 Sensor rod with »W« type single wires: IP67 Connector »W« type: IP67 (correctly mounted)						
Shock test	150 g/11 ms, IEC standard 60068-2-27						
Vibration test	30 g/10...2000 Hz, IEC standard 60068-2-6 (excluding resonant frequencies)						
EMC test	Electromagnetic emission according to EN 61000-6-3 Electromagnetic immunity according to EN 61000-6-2 The RD5 sensors fulfill the requirements of the EMC directives 2014/30/EU, UKSI 2016 No. 1091 and TR CU 020/2011 under the condition of an EMC compliant installation. <sup>3</sup>						
Operating pressure	350 bar (5076 psi)/700 bar (10,153 psi) peak (at 10 × 1 min) for sensor rod						
Magnet movement velocity	Any						

Technical data “Design/Material”, “Mechanical mounting” and “Electrical connection” on [page 6](#)

1/ With position magnet # 251 416-2

2/ For rod style »S« the linearity deviation can be higher in the first 30 mm (1.2 in.) of stroke length



3/ The cable between the sensor element and the sensor electronics housing must be mounted in an appropriately shielded environment





## Temposonics® R-Series V RD5 Analog

### Data Sheet

Design/Material	
Sensor electronics housing	Aluminum (painted), zinc die cast
Sensor rod with flange	Stainless steel 1.4301 (AISI 304)
RoHS compliance	The used materials are compliant with the requirements of EU Directive 2011/65/EU and EU Regulation 2015/863 as well as UKSI 2022 No. 622 with amendments
Stroke length	25...2540 mm (1...100 in.) for pressure-fit flange »S« 25...5080 mm (1...200 in.) for all threaded flanges
Mechanical mounting	
Mounting position	Any
Mounting instruction	Please consult the technical drawings and the operation manual (document part number: <a href="#">552063</a> )
Electrical connection	
Connection type	1 × M16 male connector (7 pin) or 1 × M12 male connector (8 pin) or cable outlet
Operating voltage	+12...30 VDC ±20 % (9.6...36 VDC); the RD5 sensors must be power supplied via an external Class 2 power source in accordance with the UL approval
Power consumption	1.2 W typical
Dielectric strength	500 VDC (DC ground to machine ground)
Polarity protection	Up to -36 VDC
Overvoltage protection	Up to 36 VDC

## TECHNICAL DRAWING – SENSOR ROD CABLES & CONNECTORS

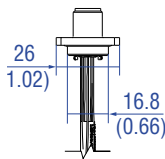
Cable »J«	Cable »K«	Cable »W«
		
Material: FEP jacket, tan Min. bending radius: 57 mm (2.2 in) Operating temperature: -40...+120 °C (-40...+248 °F) Max. cable length: 20 m (65.6 ft.)	Material: PUR jacket, black Min. bending radius: 24 mm (0.94 in) Operating temperature: -40...+80 °C (-40...+176 °F) Max. cable length: 1.15 m (3.9 ft.)	Single wires, unshielded Min. bending radius: 4 mm (0.16 in.) Operating temperature: -40...+85 °C (-40...+185 °F) Max. cable length: 0.5 m (1.6 ft.)

Connector »G«	Connector »S«	Connector »W«	Connector »E«
			
Operating temperature: -40...+105 °C (-40...+221 °F) Ingress protection: IP65/IP67 (correctly fitted) For side connection	Operating temperature: -40...+105 °C (-40...+221 °F) Ingress protection: IP67 (correctly fitted) For side connection	Operating temperature: -40...+85 °C (-40...+185 °F) Ingress protection: IP67 (correctly fitted) For side connection	Operating temperature: -40...+85 °C (-40...+185 °F) Ingress protection: IP30 For bottom connection

## TECHNICAL DRAWING – SENSOR ROD FLANGE TYPES

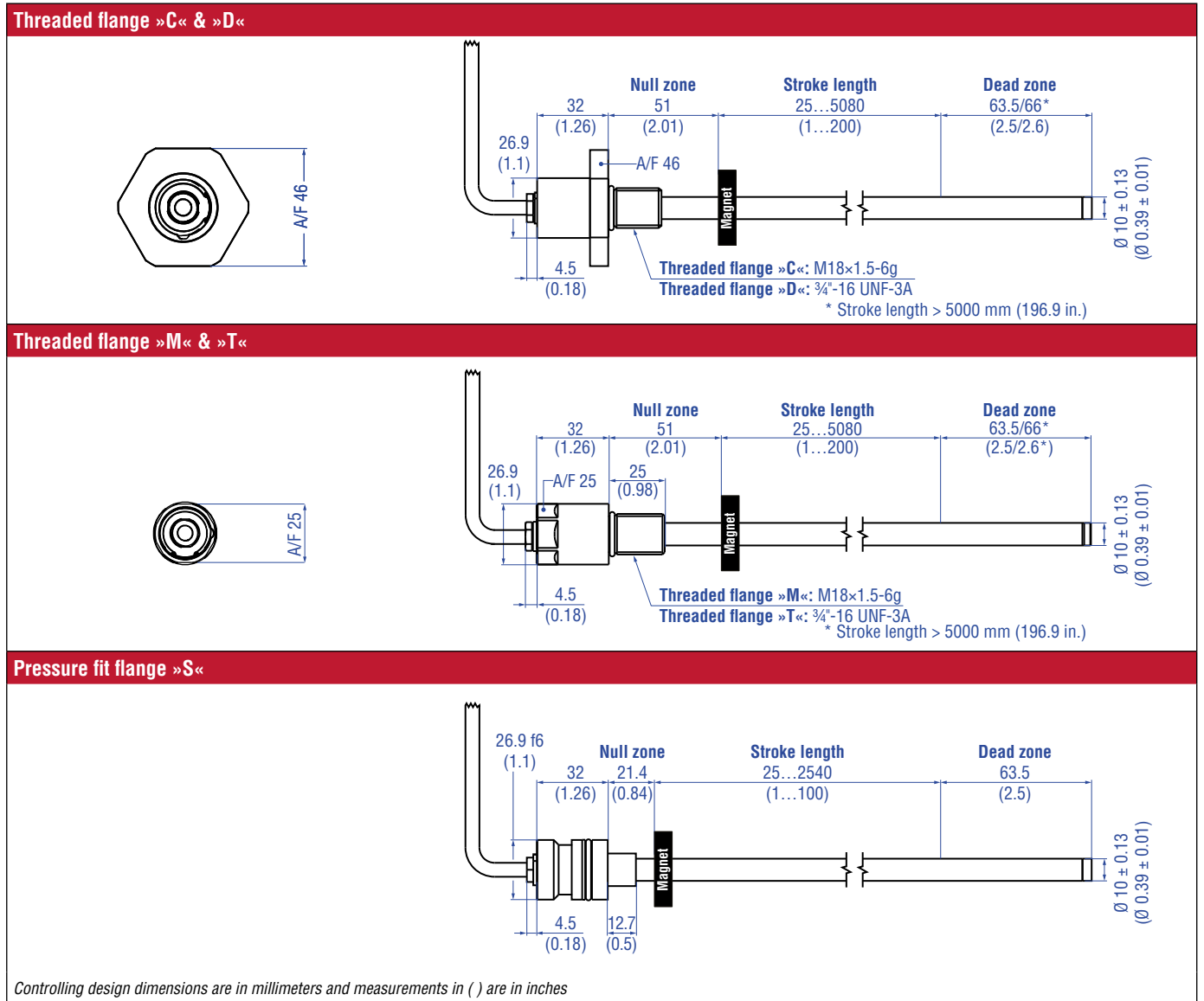
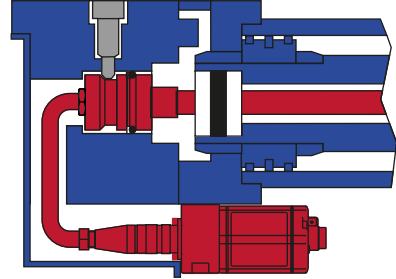

Fig. 2: Temposonics® RD5 sensor rod flange types

## TECHNICAL DRAWING – SENSOR ELECTRONICS & MOUNTING BLOCK

### RD5 with side connection

The connecting cable between the sensor electronics housing and the rod is connected to the side of the sensor electronics housing.



### Compact mounting block with side M12 mating connector, type »G«, example: Connection type D60 (connector outlet)

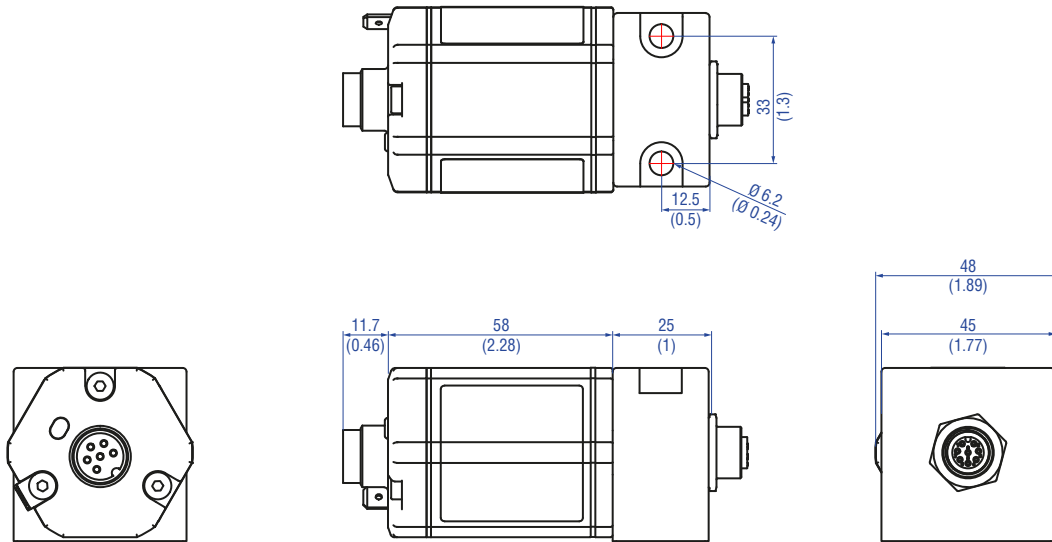

Controlling design dimensions are in millimeters and measurements in ( ) are in inches

Fig. 3: Temposonics® RD5 sensor electronics & mounting block



**TECHNICAL DRAWING – SENSOR ELECTRONICS & MOUNTING BLOCK**

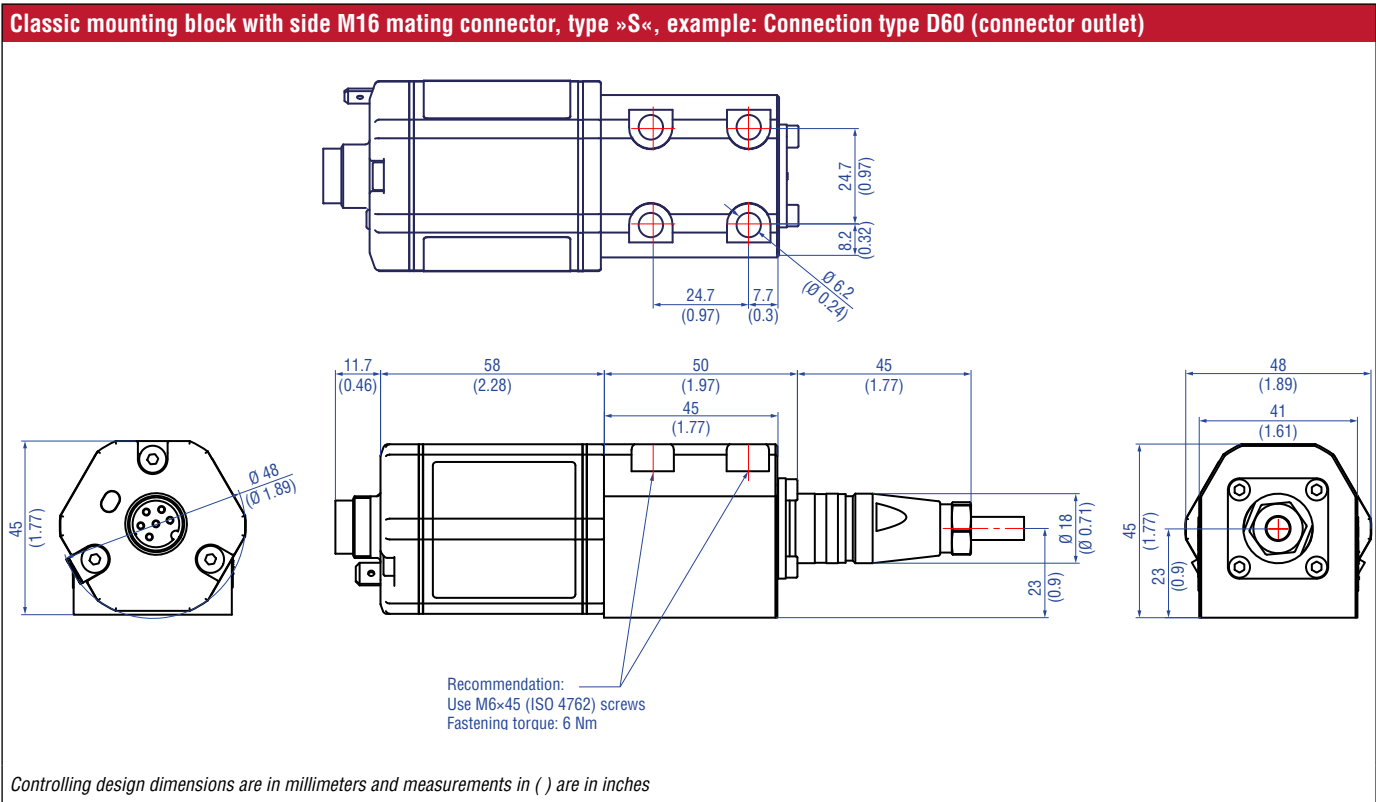
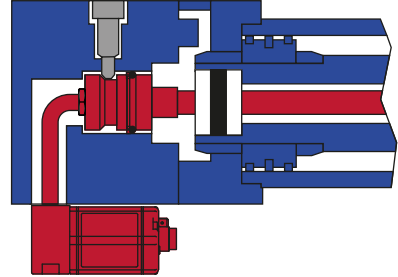

Fig. 4: Temposonics® RD5 sensor electronics & mounting block

## TECHNICAL DRAWING – SENSOR ELECTRONICS & MOUNTING BLOCK

### RD5 with bottom connection

The connecting cable between the sensor electronics housing and the rod is connected to the bottom of the sensor electronics housing.



### Compact mounting block with bottom connection and flat mating connector, type »E«, example: Connection type D60 (connector outlet)

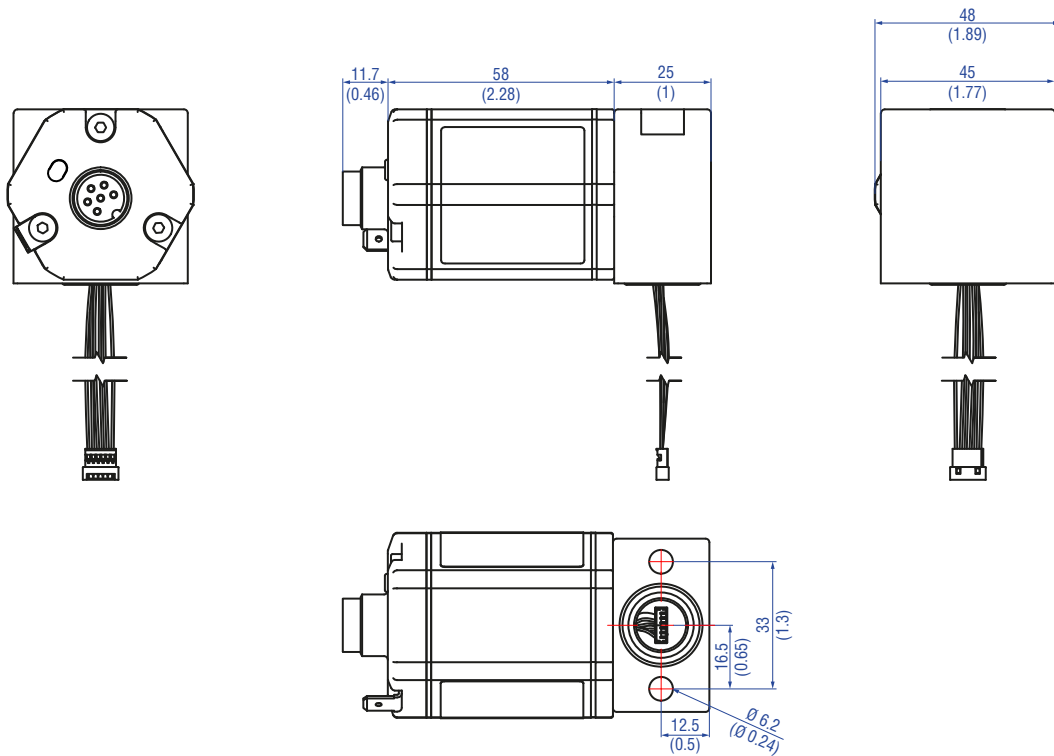

Controlling design dimensions are in millimeters and measurements in ( ) are in inches

Fig. 5: Temposonics® RD5 sensor electronics & mounting block

## TECHNICAL DRAWING – SENSOR ELECTRONICS & MOUNTING BLOCK

Classic mounting block with bottom connection and flat mating connector, type »B«, example: Connection type D60 (connector outlet)

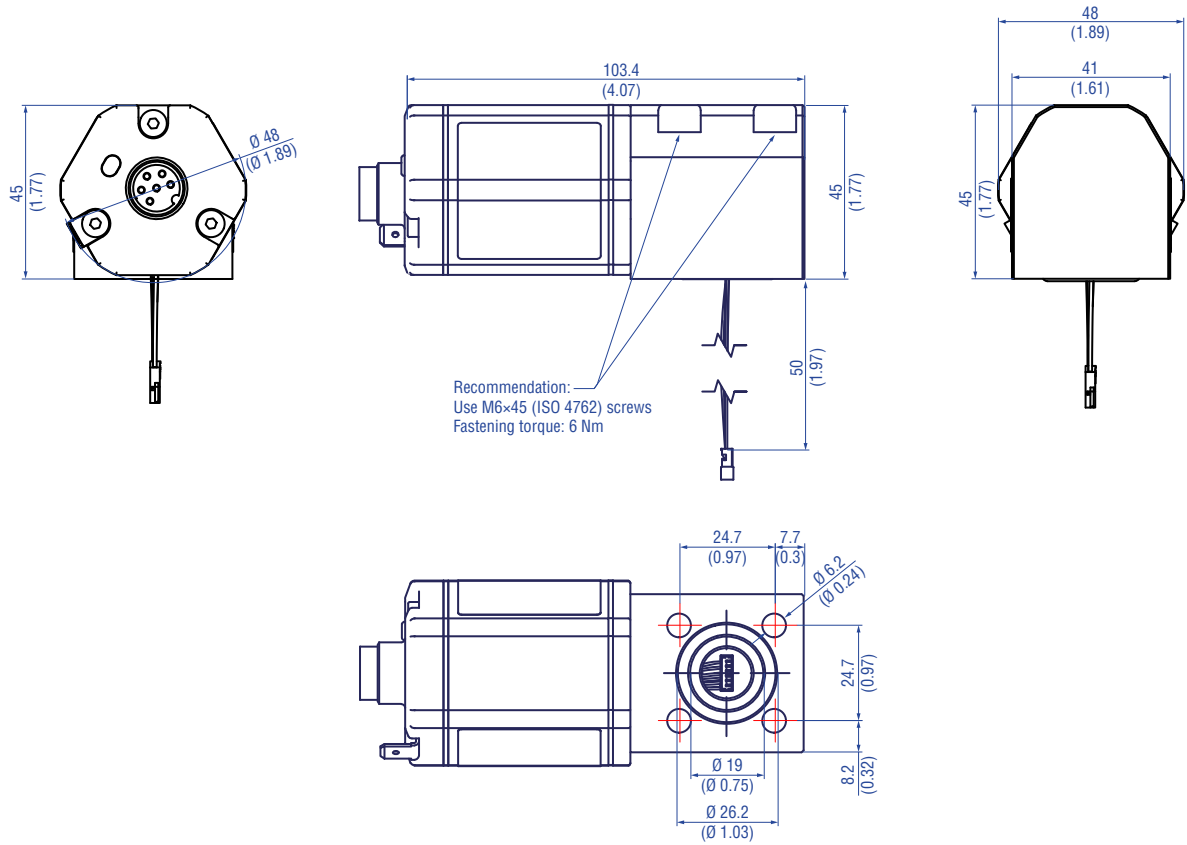

Controlling design dimensions are in millimeters and measurements in ( ) are in inches

Fig. 6: Temposonics® RD5 sensor electronics & mounting block

## RD5-E TECHNICAL DRAWING

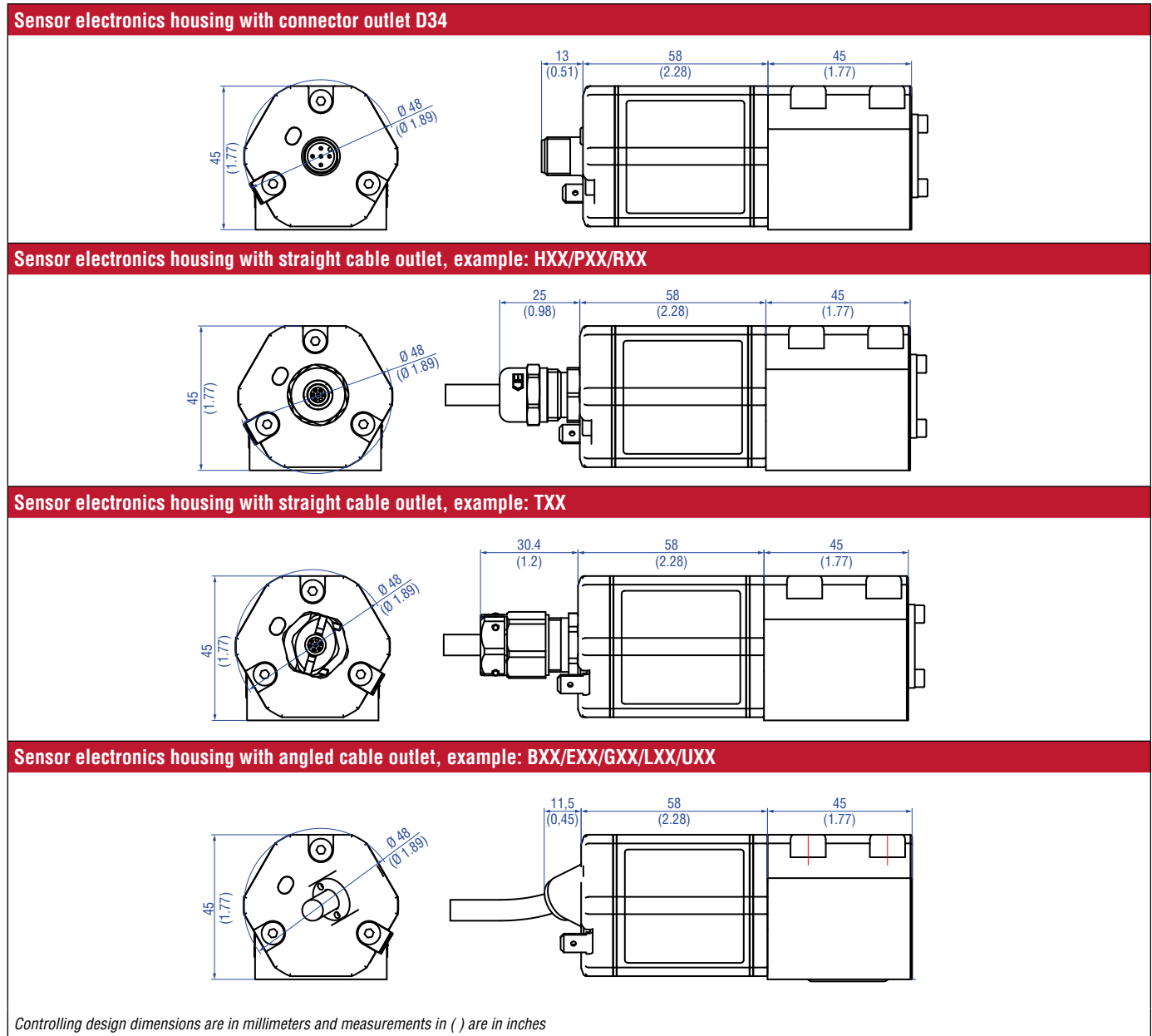



Fig. 7: Temposonics® RD5 sensor electronics housing with different outlet options

## CONNECTOR WIRING

D34			
Signal + power supply			
M12 male connector	Output	Pin	Function
 <p>View on sensor</p>	1	1	+12...30 VDC (±20 %)
		2	Position (magnet 1)
		3	DC Ground (0 V)
	2*	4	Position (magnet 2) or reverse position (magnet 1) or speed or velocity (magnet 1) or temperature inside the sensor electronics housing
		5	Signal Ground

\* order dependent

Fig. 8: Connector wiring D34

D60			
Signal + power supply			
M16 male connector	Output	Pin	Function
 <p>View on sensor</p>	1	1	Position (magnet 1)
		2	Signal Ground
	2*	3	Position (magnet 2) or reverse position (magnet 1) or speed or velocity (magnet 1) or temperature inside the sensor electronics housing
		4	Signal Ground
		5	+12...30 VDC (±20 %)
		6	DC Ground (0 V)

\* order dependent

Fig. 9: Connector wiring D60

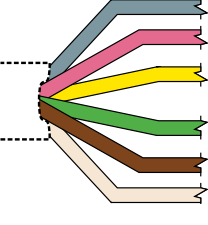
HXX or LXX/RXX or EXX/TXX or GXX/UXX			
Signal + power supply			
Cable	Output	Color	Function
	1	GY	Position (magnet 1)
		PK	Signal Ground
	2*	YE	Position (magnet 2) or reverse position (magnet 1) or speed or velocity (magnet 1) or temperature inside the sensor electronics housing
		GN	Signal Ground
		BN	+12...30 VDC (±20 %)
		WH	DC Ground (0 V)

\* order dependent

For cable type TXX, the extra red & blue wires are not used.

Fig. 10: Connector wiring cable outlet

**NOTICE**

For sensors with current output (order code section **Output A** Current), the output 1 (position (magnet 1)) must be connected in any case.

Straight cable outlet			Cable type	Angled cable outlet
H	X	X	Part no. 530 052 PUR	→ L X X Part no. 530 052
R	X	X	Part no. 530 032 PVC	→ E X X Part no. 530 032
T	X	X	Part no. 530 112 FEP	→ G X X Part no. 530 157

Fig. 11: Cable types assignment

**FREQUENTLY ORDERED ACCESSORIES** – Additional options available in our [Accessories Catalog](#)  551444

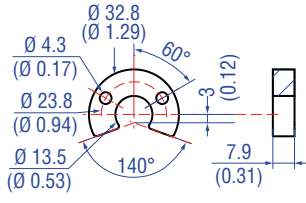
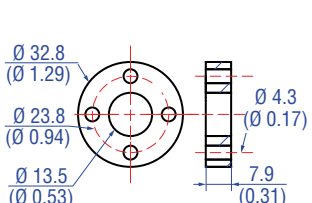
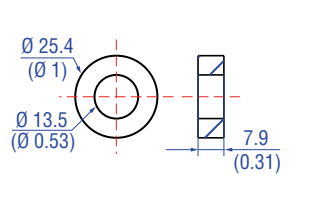
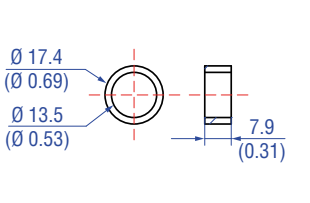
Position magnets			
			
<b>U-magnet OD33</b> Part no. 251 416-2	<b>Ring magnet OD33</b> Part no. 201 542-2	<b>Ring magnet OD25.4</b> Part no. 400 533	<b>Ring magnet OD17.4</b> Part no. 401 032
Material: PA ferrite GF20 Weight: Approx. 11 g Surface pressure: Max. 40 N/mm <sup>2</sup> Fastening torque for M4 screws: 1 Nm Operating temperature: -40...+120 °C (-40...+248 °F)	Material: PA ferrite GF20 Weight: Approx. 14 g Surface pressure: Max. 40 N/mm <sup>2</sup> Fastening torque for M4 screws: 1 Nm Operating temperature: -40...+120 °C (-40...+248 °F)	Material: PA ferrite Weight: Approx. 10 g Surface pressure: Max. 40 N/mm <sup>2</sup> Operating temperature: -40...+120 °C (-40...+248 °F)	Material: PA neobond Weight: Approx. 5 g Surface pressure: Max. 20 N/mm <sup>2</sup> Operating temperature: -40...+105 °C (-40...+221 °F)

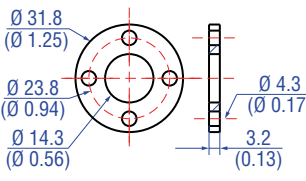
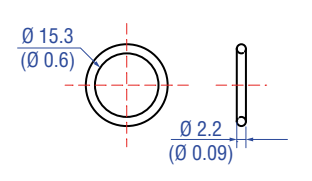
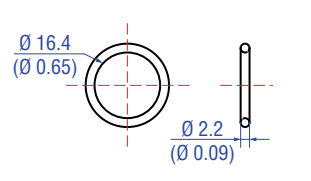
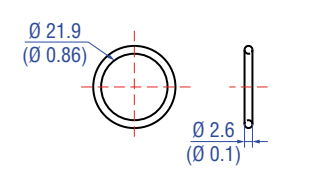
Magnet spacer			
			
<b>Magnet spacer</b> Part no. 400 633	<b>O-ring for threaded flange M18x1.5-6g</b> Part no. 401 133	<b>O-ring for threaded flange 3/4"-16 UNF-3A</b> Part no. 560 315	<b>O-ring for pressure fit flange Ø 26.9 mm</b> Part no. 560 705
Material: Aluminum Weight: Approx. 5 g Surface pressure: Max. 20 N/mm <sup>2</sup> Fastening torque for M4 screws: 1 Nm	Material: Fluoroelastomer Durometer: 75 ±5 Shore A Operating temperature: -40...+204 °C (-40...+400 °F)	Material: Fluoroelastomer Durometer: 75 ±5 Shore A Operating temperature: -40...+204 °C (-40...+400 °F)	Material: Nitrile rubber Operating temperature: -53...+107 °C (-65...+225 °F)

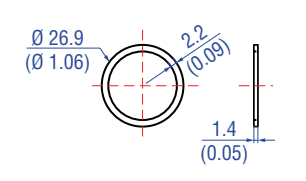
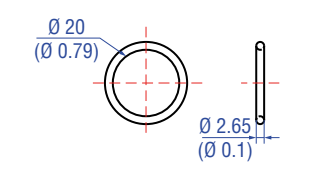
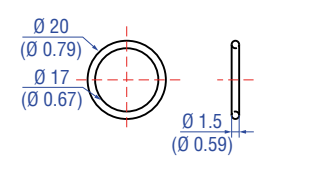
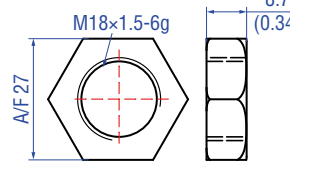
O-rings		Mounting accessories	
			
<b>Back-up ring for pressure fit flange Ø 26.9 mm</b> Part no. 560 629	<b>O-ring for classic mounting block with bottom entry »B«</b> Part no. 561 435	<b>O-ring for compact mounting block with bottom entry »E«</b> Part no. 562 405	<b>Hex jam nut M18x1.5-6g</b> Part no. 500 018
Material: Polymyte Durometer: 90 Shore A	Material: FKM Durometer: 80± 5 Shore A Operating temperature: -15...+200 °C (5...+392 °F)	Material: BUNA Durometer: 70 Shore A Operating temperature: -40...+121 °C (-40...+249,8 °F)	Material: Steel, zinc plated

Controlling design dimensions are in millimeters and measurements in ( ) are in inches

**Mounting accessories**

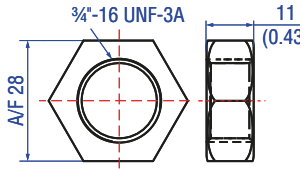

**Hex jam nut 3/4"-16 UNF-3A**  
**Part no. 500 015**

Material: Steel, zinc plated

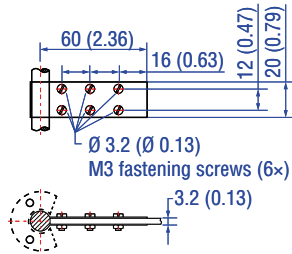



**Fixing clip**  
**Part no. 561 481**

Application: Used to secure sensor rods (Ø 10 mm (Ø 0.39 in.)) when using an U-magnet or block magnet  
Material: Brass, non-magnetic

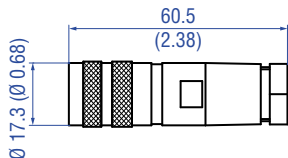
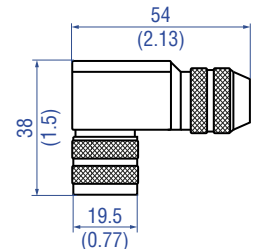
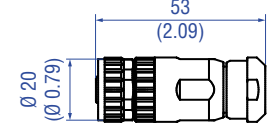
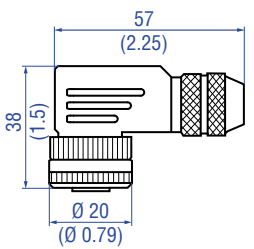
**Cable connectors\***

			
<p><b>M16 female connector (6 pin), straight</b> Part no. 370 423</p>	<p><b>M16 female connector (6 pin), angled</b> Part no. 370 460</p>	<p><b>M12 A-coded female connector (4 pin/5 pin), straight</b> Part no. 370 677</p>	<p><b>M12 A-coded female connector (5 pin), angled</b> Part no. 370 678</p>
<p>Material: Zinc nickel plated Termination: Solder Cable Ø: 6...8 mm (0.24...0.31 in.) Operating temperature: -40...+100 °C (-40...+212 °F) Ingress protection: IP65/IP67 (correctly fitted) Fastening torque: 0.6 Nm</p>	<p>Material: Zinc nickel plated Termination: Solder Cable Ø: 6...8 mm (0.24...0.31 in.) Wire: 0.75 mm<sup>2</sup> (20 AWG) Operating temperature: -40...+95 °C (-40...+203 °F) Ingress protection: IP67 (correctly fitted) Fastening torque: 0.6 Nm</p>	<p>Material: GD-Zn, Ni Termination: Screw Contact insert: CuZn Cable Ø: 4...8 mm (0.16...0.31 in.) Wire: max. 1.5 mm<sup>2</sup> (16 AWG) Operating temperature: -30...+85 °C (-22...+185 °F) Ingress protection: IP67 (correctly fitted) Fastening torque: 0.6 Nm</p>	<p>Material: GD-Zn, Ni Termination: Screw Contact insert: CuZn Cable Ø: 5...8 mm (0.2...0.31 in.) Wire: max 0.75 mm<sup>2</sup> (18 AWG) Operating temperature: -25...+85 °C (-13...+185 °F) Ingress protection: IP67 (correctly fitted) Fastening torque: 0.4 Nm</p>

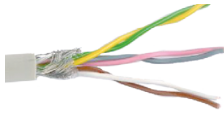
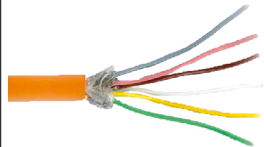
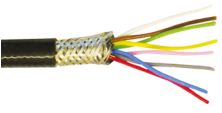
**Cables**

			
<p><b>PVC cable</b> Part no. 530 032</p>	<p><b>PUR cable</b> Part no. 530 052</p>	<p><b>FEP cable</b> Part no. 530 112</p>	<p><b>FEP cable</b> Part no. 530 157</p>
<p>Material: PVC jacket; gray Features: Twisted pair, shielded, flexible Cable Ø: 6 mm (0.23 in.) Cross section: 3 × 2 × 0.14 mm<sup>2</sup> Bending radius: 10 × D (fixed installation) Operating temperature: -40...+105 °C (-40...+221 °F)</p>	<p>Material: PUR jacket; orange Features: Twisted pair, shielded, highly flexible, halogen free, suitable for drag chains, mostly oil &amp; flame resistant Cable Ø: 6.4 mm (0.25 in.) Cross section: 3 × 2 × 0.25 mm<sup>2</sup> Bending radius: 5 × D (fixed installation) Operating temperature: -20...+80 °C (-4...+176 °F)</p>	<p>Material: FEP jacket; black Features: Twisted pair, shielded, flexible, high thermal resistance, mostly oil &amp; acid resistant Cable Ø: 7.6 mm (0.3 in.) Cross section: 4 × 2 × 0.25 mm<sup>2</sup> Bending radius: 8 – 10 × D (fixed installation) Operating temperature: -100...+180 °C (-148...+356 °F)</p>	<p>Material: FEP jacket; black Features: Twisted pair, shielded Cable Ø: 6.7 mm (0.26 in.) Cross section: 3 × 2 × 0.14 mm<sup>2</sup> Operating temperature: -40...+180 °C (-40...+356 °F)</p>

\*/ Follow the manufacturer's mounting instructions

Color of connectors and cable jacket may change. Color codes for the individual wires and technical properties remain unchanged.  
Controlling design dimensions are in millimeters and measurements in ( ) are in inches



**Cable**

**Cable sets**

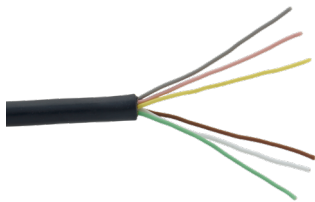

**Silicone cable**  
Part no. 530 176

Material: Silicone jacket; black  
Features: Twisted pair, shielded  
Cable Ø: 6.3 mm (0.25 in.)  
Cross section: 3 × 2 × 0.14 mm<sup>2</sup>  
Bending radius: 7 × D  
(fixed installation)  
Operating temperature: -50...+150 °C  
(-58...+302 °F)



**Cable with M12 A-coded female connector (5 pin), straight – pigtail**  
Part no. 370 673

Material: PUR jacket; black  
Feature: Shielded  
Cable length: 5 m (16.4 ft)  
Ingress protection: IP67 (correctly fitted)  
Operating temperature:  
-25...+80 °C (-13...+176 °F)



**Cable with M12 A-coded female connector (5 pin), angled – pigtail**  
Part no. 370 675

Material: PUR jacket; black  
Feature: Shielded  
Cable length: 5 m (16.4 ft)  
Ingress protection: IP67 (correctly fitted)  
Operating temperature:  
-25...+80 °C (-13...+176 °F)

**Programming tool**



**TempoLink® kit for Temposonics® R-Series V**  
Part no. TL-1-0-AD60 (for D60)  
Part no. TL-1-0-AS00 (for cable outlet)  
Part no. TL-1-0-AD34 (for D34)

- Connect wirelessly via Wi-Fi enabled device or via USB with the diagnostic tool
- Simple connectivity to the sensor via 24 VDC power line (permissible cable length: 30 m)
- User friendly interface for mobile devices and desktop computers
- See data sheet “TempoLink® smart assistant” (document part no.: [552070](#)) for further information

Controlling design dimensions are in millimeters and measurements in ( ) are in inches  
Color of connectors and cable jacket may change. Color codes for the individual wires and technical properties remain unchanged.

**Extension cables M12**



**PVC cable with M12 female connector (6 pin), straight – pigtail**

PVC cable (part no. 530 032) with M12 female connector, straight (part no. 370 677)

Order code:  
**K2-A-370677-xxxxyy-530032-0**  
(where xxxx = cable length and yy = unit in centimeters “CM” or feet “FT”)



**PUR cable with M12 female connector (6 pin), straight – pigtail**

PUR cable (part no. 530 052) with M12 female connector, straight (part no. 370 677)

Order code:  
**K2-A-370677-xxxxyy-530052-0**  
(where xxxx = cable length and yy = unit in centimeters “CM” or feet “FT”)



**FEP cable with M12 female connector (6 pin), straight – pigtail**

FEP cable (part no. 530 112) with M12 female connector, straight (part no. 370 677)

Order code:  
**K2-A-370677-xxxxyy-530112-0**  
(where xxxx = cable length and yy = unit in centimeters “CM” or feet “FT”)

**Extension cables M16**

**Notice for extension cables M12/M16**



**PVC cable with M16 female connector (6 pin), straight – pigtail**

PVC cable (part no. 530 032) with M16 female connector, straight (part no. 370 423)

Order code:  
**K2-A-370423-xxxxyy-530032-0**  
(where xxxx = cable length and yy = unit in centimeters “CM” or feet “FT”)



**PUR cable with M16 female connector (6 pin), straight – pigtail**

PUR cable (part no. 530 052) with M16 female connector, straight (part no. 370 423)

Order code:  
**K2-A-370423-xxxxyy-530052-0**  
(where xxxx = cable length and yy = unit in centimeters “CM” or feet “FT”)



**FEP cable with M16 female connector (6 pin), straight – pigtail**

FEP cable (part no. 530 112) with M16 female connector, straight (part no. 370 423)

Order code:  
**K2-A-370423-xxxxyy-530112-0**  
(where xxxx = cable length and yy = unit in centimeters “CM” or feet “FT”)

**Standard cable lengths**

Meters	Feet	Code
1.5	5.0	0150
2.0	6.6	0200
4.6	15.0	0460
5.0	16.4	0500
7.6	25.0	0760
10.0	32.8	1000
15.2	50.0	1520

For additional extension cables reference the accessories catalog for industrial sensors (document part no.: [551444](#)).

Color of connectors and cable jacket may change. Color codes for the individual wires and technical properties remain unchanged.

## ORDER CODE FOR COMPLETE SENSOR: RD5 KIT



**NOTICE**

The RD5 sensor is normally ordered as a kit containing the sensor rod and the sensor electronics housing/mounting block, all in one complete model number. For ordering the kit, use the **RD5-K** model number configurator below.

1	2	3	4	5	6	7	8	9	10	11	12	13	14	15	16	17	18	19	20	21	22	23	24	25	26	27	28	29	30			
R	D	5	K																			1										
a			b	c	d						e	f						g	h		i				j	k	l	m	n	o		

optional

<b>a</b>	<b>Sensor model</b>
R D 5	Sensor rod with detached electronics

<b>b</b>	<b>Sensor components</b>
K	Kit (includes both sensor rod and sensor electronics housing)

<b>c</b>	<b>Design</b>
C	Threaded flange M18×1.5-6g (A/F 46)
D	Threaded flange ¾"-16 UNF-3A (A/F 46)
M	Threaded flange M18×1.5-6g (A/F 25)
S	Pressure fit flange Ø 26.9 mm f6
T	Threaded flange ¾"-16 UNF-3A (A/F 25)

<b>d</b>	<b>Sensor rod cable type and length</b>
J X X X X	FEP cable, length in centimeters (range 0007...2000 cm). See historical available*, or select length from: 0020, 0030, 0080, 0300, 0500, 1000, 1500, or 2000 cm
K X X X X	PUR cable, length in centimeters (range 0007...0115 cm). See historical available*, or select length from: 0020, 0030, or 0080 cm
W X X X X	6 single wires, length in centimeters (range 0007...0050 cm). Select length from: 0007, 0010, 0015, 0020, 0030, 0040 or 0050 cm

\* Historical lengths available:

0007 cm	0023 cm	0040 cm	0115 cm
0010 cm	0025 cm	0060 cm	
0017 cm	0035 cm	0100 cm	

Non-standard lengths for cable/wires are available; must be encoded in 1 cm increments and within the specified range

<b>e</b>	<b>Sensor rod connector type</b>
E	Flat connector
G	M12 connector (only for sensor rod cable type »J« and »K«)
S	M16 connector (only for sensor rod cable type »J« and »K«)
W	M12 square panel mount connector (only for sensor rod cable type »W«) Requires RD5-C joining cable (ordered separately)

<b>f</b>	<b>Stroke length</b>
X X X X M	Flange »S«: 0025...2540 mm Flange »C«, »D«, »M«, »T«: 0025...5080 mm

Stroke length (mm)	Ordering steps
25... 500 mm	5 mm
500... 750 mm	10 mm
750...1000 mm	25 mm
1000...2500 mm	50 mm
2500...5080 mm	100 mm

X X X X U	Flange »S«: 001.0...100.0 in. Flange »C«, »D«, »M«, »T«: 001.0...200.0 in.
-----------	---

Stroke length (in.)	Ordering steps
1... 20 in.	0.2 in.
20... 30 in.	0.4 in.
30... 40 in.	1.0 in.
40...100 in.	2.0 in.
100...200 in.	4.0 in.

Non-standard stroke lengths are available; must be encoded in 5 mm/0.1 in. increments

<b>g</b>	<b>Sensor electronics mounting block with mating connector</b>
B	Classic mounting block with bottom connection and flat mating connector (only for sensor rod connector type »E«)
E	Compact mounting block with bottom connection and flat mating connector (only for sensor rod connector type »E«)
G	Compact mounting block with side M12 mating connector (only for sensor rod connector type »G« and »W«)
S	Classic mounting block with side M16 mating connector (only for sensor rod connector type »S«)

<b>h</b>	<b>Number of magnets</b>
X X	01...02 position(s) (1...2 magnet(s))

# Temposonics® R-Series V RD5 Analog

## Data Sheet

i Connection type	
<b>Connector</b>	
<b>D 3 4</b>	M12 male connector (5 pin)
<b>D 6 0</b>	M16 male connector (6 pin)
<b>Angled cable outlet</b>	
<b>E X X</b>	XX m/ft.* PVC cable (part no. 530 032) E01...E30 (1...30 m)/E03...E99 (3...99 ft.) See "Frequently ordered accessories" for cable specifications
<b>G X X</b>	XX m/ft.* FEP cable (part no. 530 157) G01...G30 (1...30 m)/G03...G99 (3...99 ft.) See "Frequently ordered accessories" for cable specifications
<b>L X X</b>	XX m/ft.* PUR cable (part no. 530 052) L01...L30 (1...30 m)/L03...L99 (3...99 ft.) (Note the temperature range of the cable!) See "Frequently ordered accessories" for cable specifications
<b>U X X</b>	XX m/ft.* Silicone cable (part no. 530 176) U01...U30 (1...30 m)/U03...U99 (3...99 ft.) See "Frequently ordered accessories" for cable specifications
<b>Straight cable outlet</b>	
<b>H X X</b>	XX m/ft.* PUR cable (part no. 530 052) H01...H30 (1...30 m)/H03...H99 (3...99 ft.) (Note the temperature range of the cable!) See "Frequently ordered accessories" for cable specifications
<b>R X X</b>	XX m/ft.* PVC cable (part no. 530 032) R01...R30 (1...30 m)/R03...R99 (3...99 ft.) See "Frequently ordered accessories" for cable specifications
<b>T X X</b>	XX m/ft.* FEP cable (part no. 530 112) T01...T30 (1...30 m)/T03...T99 (3...99 ft.) See "Frequently ordered accessories" for cable specifications
*Encode in meters if using metric stroke length. Encode in feet if using US customary stroke length.	

j System	
<b>1</b>	Standard
k Output	
<b>A</b>	Current
<b>V</b>	Voltage

l Function	
<b>1</b>	Position (1 or 2 magnets/outputs)
<b>2</b>	Position and speed (1 magnet and 2 outputs) Specify the maximum speed value in section <b>o</b>
<b>3</b>	Position and velocity (1 magnet and 2 outputs) Specify the maximum velocity value in section <b>o</b>
<b>4</b>	Position and reverse position (1 magnet and 2 outputs)
<b>5</b>	Position and temperature inside the sensor electronics housing (1 magnet and 2 outputs)
<b>6</b>	Differential (2 magnets and 1 output)

m Options	
<b>0</b>	Standard
<b>3</b>	Over range output mode

n Output range	
<b>0</b>	0...10 VDC or 4...20 mA
<b>1</b>	10...0 VDC or 20...4 mA
<b>2</b>	-10...+10 VDC or 0...20 mA
<b>3</b>	+10...-10 VDC or 20...0 mA
<b>V</b>	0...10 VDC for position, -10...+10 VDC for velocity

o Max. speed or velocity value	
<b>(optional: use when l "Function" is 2 or 3)</b>	
<input type="checkbox"/>	For metric stroke lengths encode speed or velocity in m/s for the values 0.01 to 9.99 m/s (001...999) For US customary stroke lengths encode speed or velocity in inches/s for the values 1 to 400 in./s (001...400)
To get a speed or velocity output of 0.025 m/s or 10 m/s for the R-Series V Analog, enter code (00E) for 0.025 m/s or (A00) for 10.0 m/s in the order code.	

NOTICE	
<ul style="list-style-type: none"> <li>Specify the number of magnets for your application and order the magnets separately.</li> <li>The number of magnets is limited by the stroke length. The minimum allowed distance between magnets (i.e. front face of one to the front face of the next one) is 75 mm (3 in.).</li> <li>Use magnets of the same type for differential/multi-position measurement.</li> </ul>	

## DELIVERY



**RD5-K-C/D/M/T:**

Sensor, O-ring

**RD5-K-S:**

Sensor, O-ring, back-up ring

Accessories have to be ordered separately.

Manuals, Software & 3D Models available at:  
[www.temposonics.com](http://www.temposonics.com)

## ORDER CODE FOR SENSOR ROD ONLY



The RD5 sensor rod with cable/wires and connector can be ordered separately as a spare or replacement. For ordering just the sensor rod components, use the **RD5-R** model number configurator below.

1	2	3	4	5	6	7	8	9	10	11	12	13	14	15	16	17	18	19	20	21	22	23	
R	D	5	R																				
a			b	c	d						e	f				g	h	i	j	k			
optional																							

a	Sensor model
R D 5	Sensor rod with detached electronics

b	Sensor components
R	Sensor rod assembly with cable and connector

c	Design
C	Threaded flange M18×1.5-6g (A/F 46)
D	Threaded flange ¾"-16 UNF-3A (A/F 46)
M	Threaded flange M18×1.5-6g (A/F 25)
S	Pressure fit flange Ø 26.9 mm f6
T	Threaded flange ¾"-16 UNF-3A (A/F 25)

d	Sensor rod cable type and length
J X X X X	FEP cable, length in centimeters (range 0007...2000 cm). See historical available*, or select length from: 0020, 0030, 0080, 0300, 0500, 1000, 1500, or 2000 cm
K X X X X	PUR cable, length in centimeters (range 0007...0115 cm). See historical available*, or select length from: 0020, 0030, or 0080 cm
W X X X X	6 single wires, length in centimeters (range 0007...0050 cm). Select length from: 0007, 0010, 0015, 0020, 0030, 0040 or 0050 cm
* Historical lengths available:	
0007 cm 0023 cm 0040 cm 0115 cm	
0010 cm 0025 cm 0060 cm	
0017 cm 0035 cm 0100 cm	
Non-standard lengths for cable/wires are available; must be encoded in 1 cm increments and within the specified range	

e	Rod connector type
E	Flat connector
G	M12 connector (only for sensor rod cable type »J« and »K«)
S	M16 connector (only for sensor rod cable type »J« and »K«)
W	M12 square panel mount connector (only for sensor rod cable type »W«) Requires RD5-C joining cable (ordered separately)

f	Stroke length
X X X X M	Flange »S«: 0025...2540 mm Flange »C«, »D«, »M«, »T«: 0025...5080 mm
Stroke length (mm)	Ordering steps
25... 500 mm	5 mm
500... 750 mm	10 mm
750... 1000 mm	25 mm
1000... 2500 mm	50 mm
2500... 5080 mm	100 mm
X X X X U	Flange »S«: 001.0...100.0 in. Flange »C«, »D«, »M«, »T«: 001.0...200.0 in.
Stroke length (in.)	Ordering steps
1... 20 in.	0.2 in.
20... 30 in.	0.4 in.
30... 40 in.	1.0 in.
40... 100 in.	2.0 in.
100... 200 in.	4.0 in.
Non-standard stroke lengths are available; must be encoded in 5 mm/0.1 in. increments	

**NOTICE**  
Enter analog output parameter values (sections **g...i** or **g...k**) to match the same parameters of the RD5-K or RD5-E that will be connected to this RD5-R.

g	Output
A	Current
V	Voltage

h	Function
1	Position (1 or 2 magnets/outputs)
2	Position and speed (1 magnet and 2 outputs) Specify the maximum speed value in section <b>k</b>
3	Position and velocity (1 magnet and 2 outputs) Specify the maximum velocity value in section <b>k</b>
4	Position and reverse position (1 magnet and 2 outputs)
5	Position and temperature inside the sensor electronics housing (1 magnet and 2 outputs)
6	Differential (2 magnets and 1 output)

## Temposonics® R-Series V RD5 Analog

### Data Sheet

i	Options
0	Standard
3	Over range output mode

j	Output range
0	0...10 VDC or 4...20 mA
1	10...0 VDC or 20...4 mA
2	-10...+10 VDC or 0...20 mA
3	+10...-10 VDC or 20...0 mA
V	0...10 VDC for position, -10...+10 VDC for velocity

k	Max. speed or velocity value		
<b>(optional: use when h "Function" is 2 or 3)</b>			
<input type="checkbox"/>	<input type="checkbox"/>	<input type="checkbox"/>	For metric stroke lengths encode speed or velocity in m/s for the values 0.01 to 9.99 m/s (001...999) For US customary stroke lengths encode speed or velocity in inches/s for the values 1 to 400 in./s (001...400)
To get a speed or velocity output of 0.025 m/s or 10 m/s for the R-Series V Analog, enter code (00E) for 0.025 m/s or (A00) for 10.0 m/s in the order code.			

## DELIVERY



### RD5-R-C/D/M/T:

Sensor rod, O-ring

Accessories have to be ordered separately.

### RD5-R-S:

Sensor rod, O-ring, back-up ring

Manuals, Software & 3D Models available at:  
[www.temposonics.com](http://www.temposonics.com)

## ORDER CODE FOR SENSOR ELECTRONICS AND MOUNTING BLOCK ONLY



**NOTICE**

The RD5 sensor electronics housing with mounting block can be ordered separately as a spare or replacement. For ordering just the sensor electronics components, use the **RD5-E** model number configurator below.

1	2	3	4	5	6	7	8	9	10	11	12	13	14	15	16	17	18															
R	D	5	E							1																						
a			b			c			d			e			f			g			h			i			j			k		

optional

a	Sensor model
R D 5	Sensor rod with detached electronics

b	Sensor components
E	Sensor electronics assembly with mounting block and mating connector

c	Design
B	Classic mounting block with bottom connection and flat mating connector (only for sensor rod connector type »E«)
E	Compact mounting block with bottom connection and flat mating connector (only for sensor rod connector type »E«)
G	Compact mounting block with side M12 mating connector (only for sensor rod connector type »G« and »W«)
S	Classic mounting block with side M16 mating connector (only for sensor rod connector type »S«)

d	Number of magnets
X X	01...02 position(s) (1...2 magnet(s))

e	Connection type
<b>Connector</b>	
D 3 4	M12 male connector (5 pin)
D 6 0	M16 male connector (6 pin)
<b>Angled cable outlet</b>	
E X X	XX m* PVC cable (part no. 530 032) E01...E30 (1...30 m) See "Frequently ordered accessories" for cable specifications
G X X	XX m* FEP cable (part no. 530 157) G01...G30 (1...30 m) See "Frequently ordered accessories" for cable specifications
L X X	XX m* PUR cable (part no. 530 052) L01...L30 (1...30 m) (Note the temperature range of the cable!) See "Frequently ordered accessories" for cable specifications
U X X	XX m* Silicone cable (part no. 530 176) U01...U30 (1...30 m) See "Frequently ordered accessories" for cable specifications
<b>Straight cable outlet</b>	
H X X	XX m* PUR cable (part no. 530 052) H01...H30 (1...30 m) (Note the temperature range of the cable!) See "Frequently ordered accessories" for cable specifications
R X X	XX m* PVC cable (part no. 530 032) R01...R30 (1...30 m) See "Frequently ordered accessories" for cable specifications
T X X	XX m* FEP cable (part no. 530 112) T01...T30 (1...30 m) See "Frequently ordered accessories" for cable specifications

\* For RD5-E the cable lengths are in meters only. To convert feet to meters use the calculation: # of feet multiplied by 0.305 = # of meters and round up to the next whole meter.

## Temposonics® R-Series V RD5 Analog

Data Sheet

f System	
1	Standard

**NOTICE**

Enter analog output parameter values (sections **g**...**j** or **g**...**k**) to match the same parameters of the RD5-K or RD5-R that will be connected to this RD5-E.

g Output	
A	Current
V	Voltage

h Function	
1	Position (1 or 2 magnets/outputs)
2	Position and speed (1 magnet and 2 outputs) Specify the maximum speed value in section <b>k</b>
3	Position and velocity (1 magnet and 2 outputs) Specify the maximum velocity value in section <b>k</b>
4	Position and reverse position (1 magnet and 2 outputs)
5	Position and temperature inside the sensor electronics housing (1 magnet and 2 outputs)
6	Differential (2 magnets and 1 output)

i Options	
0	Standard
3	Over range output mode

j Output range	
0	0...10 VDC or 4...20 mA
1	10...0 VDC or 20...4 mA
2	-10...+10 VDC or 0...20 mA
3	+10...-10 VDC or 20...0 mA
V	0...10 VDC for position, -10...+10 VDC for velocity

k Max. speed or velocity value	
<b>(optional: use when <b>h</b> "Function" is <b>2</b> or <b>3</b>)</b>	
<input type="text"/>	<input type="text"/>
For metric stroke lengths encode speed or velocity in m/s for the values 0.01 to 9.99 m/s (001...999) For US customary stroke lengths encode speed or velocity in inches/s for the values 1 to 400 in./s (001...400)	
To get a speed or velocity output of 0.025 m/s or 10 m/s for the R-Series V Analog, enter code (00E) for 0.025 m/s or (A00) for 10.0 m/s in the order code.	

**NOTICE**

- Specify the number of magnets for your application and order the magnets separately.
- The number of magnets is limited by the stroke length. The minimum allowed distance between magnets (i.e. front face of one to the front face of the next one) is 75 mm (3 in.).
- Use magnets of the same type for differential/multi-position measurement.

## DELIVERY



**RD5-E:**  
As ordered

Accessories have to be ordered separately.

Manuals, Software & 3D Models available at:  
[www.temposonics.com](http://www.temposonics.com)



## ORDER CODE FOR RD5 JOINING CABLE – RD5-C

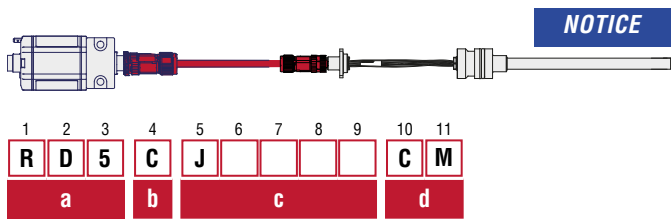

The **RD5-C** joining cable is required when the sensor rod connector is the M12 square panel mount connector, **W**. For ordering the joining cable, use the RD5-C model number configurator below.

<b>a</b>	<b>Sensor model</b>
R D 5	Sensor rod with detached electronics
<b>b</b>	<b>Sensor components</b>
C	Joining cable (M12 to M12)
<b>c</b>	<b>Design</b>
J X X X X	FEP cable Length in centimeters (range 0050...2000 cm) Standard lengths are: 0050, 0100, 0300, 0500, 1000, 1500, 2000 cm
Non-standard lengths for the joining cable are available; must be encoded in 1 cm increments and within the specified range	
<b>d</b>	<b>Unit of measure</b>
C M	Length in centimeters

## DELIVERY



Manuals, Software & 3D Models available at:  
[www.temposonics.com](http://www.temposonics.com)

## GLOSSARY

### A

#### Analog output

For a sensor with analog output, the measured value is output as an analog voltage signal or current signal.

### D

#### Differential

For differential measurement, the distance between the two position magnets is output as a value.  
(→ multi-position measurement)

### M

#### Max. speed or velocity value

For speed or velocity, the output value generated is scaled based on the maximum speed or velocity value indicated in the order code.

#### Measuring direction

- Forward: Values increasing from sensor electronics housing to rod end/profile end
- Reverse: Values decreasing from sensor electronics housing to rod end/profile end

#### Multi-position measurement

During the measurement cycle, the positions of every magnet on the sensor are simultaneously reported. The velocity or speed is continuously calculated based on these changing position values as the magnets are moved.

### O

#### Over range output mode

When enabled this mode allows the position output values to continue to increase or decrease when the magnet travels beyond the active stroke range.

### R

#### Resolution

The sensor precisely measures time to provide the position measurement. For the analog output the measured time value is converted into an analog voltage signal or current signal using a high-performance **D**igital to **A**nalog **C**onverter (DAC) having 16 bits of resolution.

### S

#### Speed

The output value for speed indicates how fast the position magnet is being moved, independent of the measuring direction. (→ Velocity)

### T

#### Temperature inside the sensor electronics housing

The temperature inside the sensor electronics housing is reported as an analog voltage signal or current signal. For each output range, the 0 % output value has the factory default setpoint at -40 °C, and the 100 % output value has the default setpoint at +100 °C.

Note: A dedicated temperature chip is used for the output signal and its values may vary from those reported on the TempoLink® application screen.

### V

#### Velocity

The output value for velocity indicates how fast the position magnet is being moved, and in which direction. (→ Speed)

**UNITED STATES**  
**Temposonics, LLC**  
Americas & APAC Region  
3001 Sheldon Drive  
Cary, N.C. 27513  
Phone: +1 919 677-0100  
E-mail: [info.us@temposonics.com](mailto:info.us@temposonics.com)

**GERMANY**  
**Temposonics GmbH & Co. KG**  
EMEA Region & India  
Auf dem Schüffel 9  
58513 Lüdenscheid  
Phone: +49 2351 9587-0  
E-mail: [info.de@temposonics.com](mailto:info.de@temposonics.com)

**ITALY**  
Branch Office  
Phone: +39 030 988 3819  
E-mail: [info.it@temposonics.com](mailto:info.it@temposonics.com)

**FRANCE**  
Branch Office  
Phone: +33 6 14 060 728  
E-mail: [info.fr@temposonics.com](mailto:info.fr@temposonics.com)

**UK**  
Branch Office  
Phone: +44 79 21 83 05 86  
E-mail: [info.uk@temposonics.com](mailto:info.uk@temposonics.com)

**SCANDINAVIA**  
Branch Office  
Phone: +46 70 29 91 281  
E-mail: [info.sca@temposonics.com](mailto:info.sca@temposonics.com)

**CHINA**  
Branch Office  
Phone: +86 21 3405 7850  
E-mail: [info.cn@temposonics.com](mailto:info.cn@temposonics.com)

**JAPAN**  
Branch Office  
Phone: +81 3 6416 1063  
E-mail: [info.jp@temposonics.com](mailto:info.jp@temposonics.com)

**Document Part Number:**  
552217 Revision B (EN) 10/2025



**temposonics.com**